



卫生管配件系列  
SANITARY PIPE FITTINGS SERIES



# 关于金斯顿

## About KST



KST.浙江金斯流体设备有限公司 是专业生产高精度不锈钢卫生级阀门、管件及泵等流体设备的专业厂家, 产品广泛应用于乳品、食品饮料、啤酒、生物制药及日用化工等工业领域。产品为遵循GMP和FDA规范要求, 特研制出高端无菌隔膜阀以适应医药行业需求。

KST.金斯顿公司积极引进国内外先进的生产设备和制造工艺。产品严格按ISO、DIN、IDF和3A等各国工业标准要求生产, 坚持把优质材料, 先进的工艺设计, 严格的制造标准及质量保证体系紧密结合在一起, 对产品质量实行全程监控, 并已获得ISO9001国际质量认证。目前,KST.卫生级阀门系列产品辐射全国并远销欧美,中东及东南亚地区,广泛受到客户好评!

KST.金斯顿公司始终以先进的管理体系, 一流的服务, 不断提升企业自身的品质, 使“KST.金斯顿”真正成为让国内外客户满意的合作伙伴。KST.公司欢迎您的光临!

Zhejiang KINGSTONE fluid equipment Co., Ltd. was founded in the last century 90 's, is a comprehensive enterprise specialized in R & D, design, production, sales and service. After many years of development in the health industry has formed its own quality management system. Products to comply with the GMP and FDA specification requirements, the development of high-end sterile diaphragm valve to meet the needs of the pharmaceutical industry. Products to comply with the GMP and FDA specification requirements, the development of high-end sterile diaphragm valve to meet the needs of the pharmaceutical industry.

KST. company actively introduce domestic and foreign advanced production equipment and manufacturing process. Products strictly according to ISO, DIN, IDF and 3A, and other industrial standards require production, adhere to the quality materials, advanced technology design, strict manufacturing standards and quality assurance system closely together, the implementation of product quality monitoring, and has obtained ISO9001 international quality certification. At present, the KST. sanitary grade valve series products are exported to Europe and America, the Middle East and Southeast Asia, the Middle East and Southeast Asia, widely praised by customers!

Zhejiang KINGSTONE fluid equipment Co., Ltd. has always been to the advanced management system, first-class service, and constantly improve the quality of their own, so that the "KST. Kingston" truly become the domestic and foreign customers satisfied with the partners. KST. welcome your presence!



粗糙度检测仪  
Roughness detector



光谱仪  
Spectroscopic instrument



全自动焊机  
Automatic welder



KST— 品质源自努力！

KST—The high quality comes from efforts！



金斯顿隔膜阀在众多国际生物制药厂商中广泛应用







## 目录 Catalog

# 1

卫生级管件 (ISO/IDF)	
sanitary pipe fittings	05-08
卫生级管件 (3A)	
sanitary pipe fittings	09-14
卫生级管件 (SMS)	
sanitary pipe fittings	15-18
卫生级管件 (DIN)	
sanitary pipe fittings	19-24

# 3

卫生级卡箍接头	
Sanitary Ferrule	36-46





## 2

卫生级由任 (ISO/IDF) Sanitary Unions	25-26
卫生级由任 (3A) Sanitary Unions	27-28
卫生级由任 (SMS) Sanitary Unions	29-31
卫生级由任 (DIN) Sanitary Unions	32-34
由任密封圈 Sanitary Unions	35

## 4

卫生级人孔盖系列 Sanitary manhole covers	47-48
Y 型过滤器 Y-type strainer	49-50

# 卫生级管件(ISO/IDF) SANITARY PIPE FITTINGS

90°焊接式弯头  
90° Welded Elbow

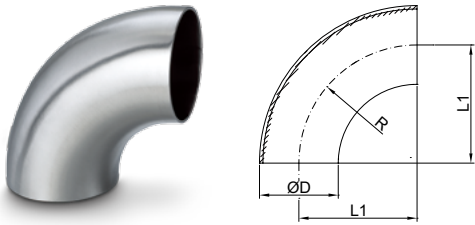

ISO/IDF	No.KST-P001		
Size	D	L1	R
1"	25.4	33.5	33.5
1 1/4"	31.8	38.0	38.0
1 1/2"	38.1	48.5	48.5
2"	50.8	60.5	60.5
2 1/2"	63.5	76.2	76.2
3"	76.2	88.5	88.5
3 1/2"	89.0	103.5	103.5
4"	101.6	122.0	122.0
4 1/2"	114.3	152.4	152.4
5"	133.0	190.5	190.5
6"	159.0	228.6	228.6

90°卡箍式弯头  
90° Clamped Elbow

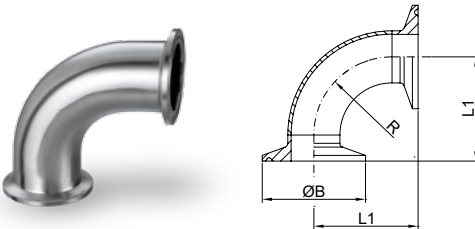

ISO/IDF	No.KST-P002		
Size	B	L1	R
1"	50.5	55.0	33.5
1 1/4"	50.5	59.5	38.0
1 1/2"	50.5	70.0	48.5
2"	64.0	82.0	60.5
2 1/2"	77.5	105.0	76.2
3"	91.0	110.0	88.5
3 1/2"	106.0	125.0	103.5
4"	119.0	143.5	122.0

45°焊接式弯头  
45° Welded Elbow

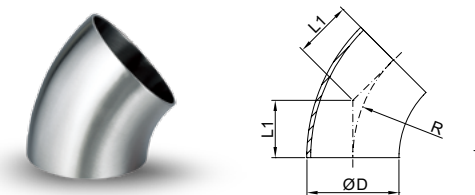

ISO/IDF	No.KST-P003		
Size	D	L1	R
1"	25.4	13.9	33.5
1 1/4"	31.8	15.7	38.0
1 1/2"	38.1	20.1	48.5
2"	50.8	25.1	60.5
2 1/2"	63.5	34.6	76.2
3"	76.2	36.7	88.5
3 1/2"	89.0	42.9	103.5
4"	101.6	50.8	122.0

45°焊接式弯头长型  
45° Welded Elbow with straight ends

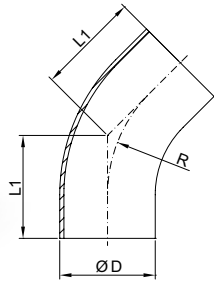

ISO/IDF No.KST-P004

Size	D	L1	R
1"	25.4	35.0	33.5
1 1/4"	31.8	38.0	38.0
1 1/2"	38.1	45.0	48.5
2"	50.8	50.0	60.5
2 1/2"	63.5	64.0	76.2
3"	76.2	70.0	88.5
4"	101.6	75.0	122.0

45°卡箍式弯头  
45° Clamped Elbow

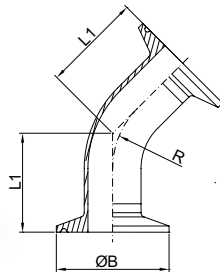

ISO/IDF No.KST-P005

Size	B	L1	R
1"	50.5	35.4	33.5
1 1/4"	50.5	37.2	38.0
1 1/2"	50.5	41.6	48.5
2"	64.0	46.6	60.5
2 1/2"	77.5	56.1	76.2
3"	91.0	58.2	88.5
3 1/2"	106.0	64.4	103.5
4"	119.0	72.3	122.0

焊接式四通  
Welded Cross

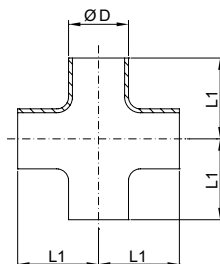

ISO/IDF No.KST-P006

Size	D	L1
1"	25.4	33.5
1 1/4"	31.8	38.1
1 1/2"	38.1	48.5
2"	50.8	60.5
2 1/2"	63.5	70.0
3"	76.2	76.0
3 1/2"	89.0	86.0
4"	101.6	100.0



# 卫生级管件(ISO/IDF) SANITARY PIPE FITTINGS

焊接式三通  
Welded Tee

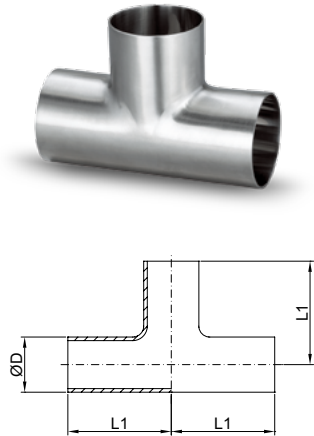

ISO/IDF

No.KST-P007

Size	D	L1
1"	25.4	33.5
1 1/4"	31.8	38.1
1 1/2"	38.1	48.5
2"	50.8	60.5
2 1/2"	63.5	70
3"	76.2	76
3 1/2"	89	86
4"	101.6	95
4 1/2"	114.3	105
5"	133	124
6"	159	143

卡箍式三通  
Clamped Tee

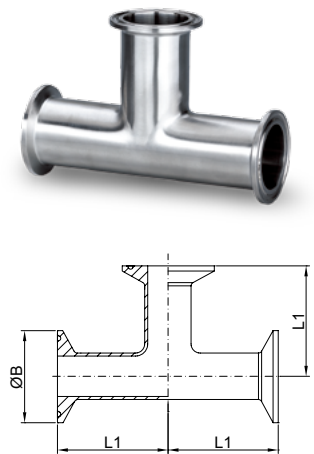

ISO/IDF

No.KST-P008

Size	B	L1
1"	50.5	55
1 1/4"	50.5	59.5
1 1/2"	50.5	70
2"	64	82
2 1/2"	77.5	91.5
3"	91	97.5
3 1/2"	106	107.5
4"	119	116.5

焊接式大小头  
Welded Reducer

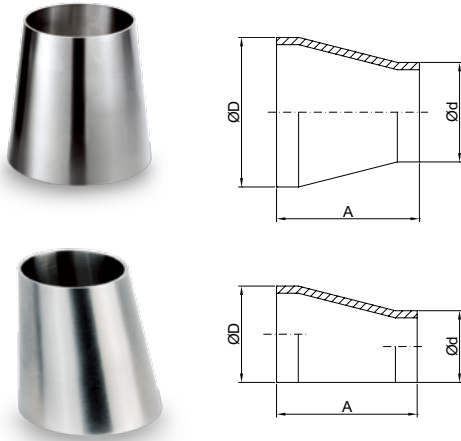

ISO/IDF

No.KST-P009

Size	A	D	d
1.0"-0.75"	38	25.4	19.05
1.25"-1.0"	50	31.8	25.4
1.5"-1.0"	50	38.1	25.4
1.5"-1.25"	50	38.1	31.8
2.0"-1.0"	67	50.8	25.4
2.0"-1.25"	67	50.8	31.8
2.0"-1.5"	67	50.8	38.1
2.5"-1.0"	67	63.5	25.4
2.5"-1.5"	67	63.5	38.1
2.5"-2.0"	67	63.5	50.8
3.0"-1.5"	67	76.2	38.1
3.0"-2.0"	67	76.2	50.8
3.0"-2.5"	67	76.2	63.5
3.5"-2.0"	67	88.9	50.8
3.5"-2.5"	67	88.9	63.5
3.5"-3.0"	67	88.9	76.2
4.0"-2.0"	101.6	101.6	50.8
4.0"-2.5"	101.6	101.6	63.5
4.0"-3.0"	101.6	101.6	76.2
4.0"-3.5"	101.6	101.6	88.9

卡箍式大小头  
Clamped Reducer

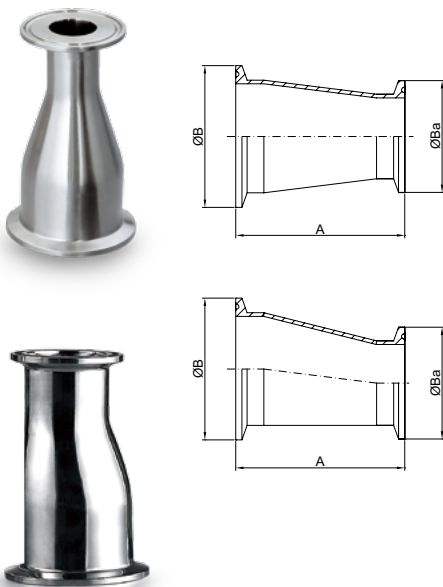

ISO/IDF

No.KST-P010

Size	A	B	Ba
1.0"-0.75"	80	50.5	34
1.25"-1.0"	92	50.5	50.5
1.5"-1.0"	92	50.5	50.5
1.5"-1.25"	92	50.5	50.5
2.0"-1.0"	109	64	50.5
2.0"-1.25"	109	64	50.5
2.0"-1.5"	109	64	50.5
2.5"-1.0"	109	77.5	50.5
2.5"-1.5"	109	77.5	50.5
2.5"-2.0"	109	77.5	64
3.0"-1.5"	109	91	50.5
3.0"-2.0"	109	91	64
3.0"-2.5"	109	91	77.5
3.5"-2.0"	109	106	64
3.5"-2.5"	109	106	77.5
3.5"-3.0"	109	106	91
4.0"-2.0"	143.6	119	64
4.0"-2.5"	143.6	119	77.5
4.0"-3.0"	143.6	119	91
4.0"-3.5"	143.6	119	106

# 卫生级管件(3A) SANITARY PIPE FITTINGS

90°焊接式弯头  
90° Welded Elbow

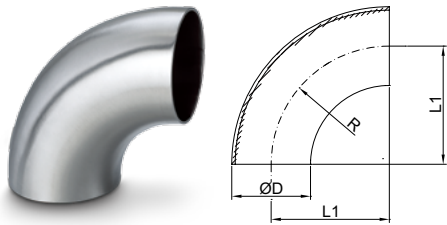

3A

No.KST-P011

Size	D	L1	R
1/2"	12.7	19.1	19.1
3/4"	19.1	28.6	28.6
1"	25.4	38.1	38.1
1 1/2"	38.1	57.2	57.2
2"	50.8	76.2	76.2
2 1/2"	63.5	95.3	95.3
3"	76.2	114.3	114.3
4"	101.6	152.4	152.4
5"	127.0	190.5	190.5
6"	152.4	228.6	228.6

90°焊接式弯头长型  
90° Welded Elbow (Long Type)

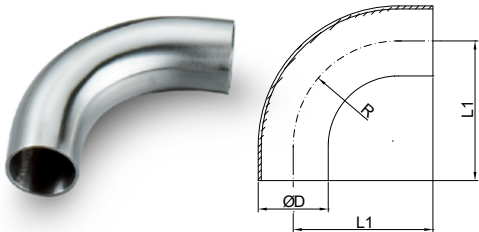

3A

No.KST-P012

Size	D	L1	R
1/2"	12.7	25.4	19.1
3/4"	19.1	38.1	28.6
1"	25.4	52.4	38.1
1 1/2"	38.1	74.6	57.2
2"	50.8	103.2	76.2
2 1/2"	63.5	131.8	95.3
3"	76.2	160.3	114.3
4"	101.6	211.1	152.4
6"	152.4	292.1	228.6

90°卡箍式弯头  
90° Clamped Elbow

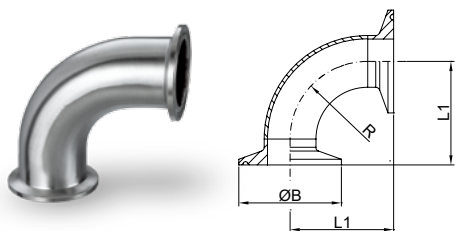

3A

No.KST-P013

Size	B	L1	R
1"	50.5	50.8	38.1
1 1/2"	50.5	69.9	57.2
2"	64.0	88.9	76.2
2 1/2"	77.5	108.0	95.3
3"	91.0	127.0	114.3
4"	119.0	168.2	152.4
6"	167.0	250.8	228.6



45°焊接式弯头  
45° Welded Elbow

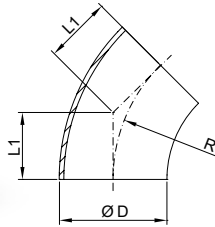

3A No.KST-P014

Size	D	L1	R
1"	25.4	15.8	38.1
1 1/2"	38.1	23.8	57.2
2"	50.8	31.8	76.2
2 1/2"	63.5	39.6	95.3
3"	76.2	47.6	114.3
4"	101.6	63.5	152.4
6"	152.4	94.7	228.6

45°焊接式弯头长型  
45° Welded Elbow (Long Type)

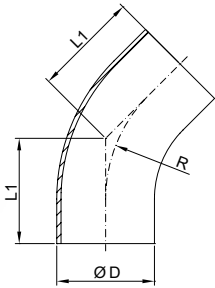

3A No.KST-P015

Size	D	L1	R
1"	25.4	30.2	38.1
1 1/2"	38.1	41.3	57.2
2"	50.8	58.7	76.2
2 1/2"	63.5	76.2	95.3
3"	76.2	93.7	114.3
4"	101.6	122.2	152.4
6"	152.4	158.2	228.6

45°卡箍式弯头  
45° Clamped Elbow

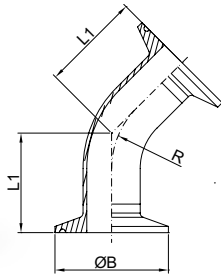

3A No.KST-P016

Size	B	L1	R
1"	50.5	28.5	38.1
1 1/2"	50.5	36.5	57.2
2"	64.0	44.5	76.2
2 1/2"	77.5	52.3	95.3
3"	91.0	60.3	114.3
4"	119.0	76.2	152.4

180°焊接式弯头  
180° Welded Elbow

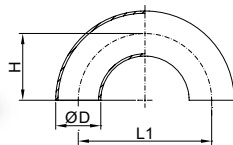

3A No.KST-P017

Size	D	L1	H
1"	25.4	76.2	38.1
1 1/2"	38.1	114.4	57.2
2"	50.8	152.4	76.2
2 1/2"	63.5	190.6	95.3
3"	76.2	228.6	114.3
4"	101.6	304.8	152.4

# 卫生级管件(3A) SANITARY PIPE FITTINGS

焊接式四通加长型  
Welded Cross(long-type)

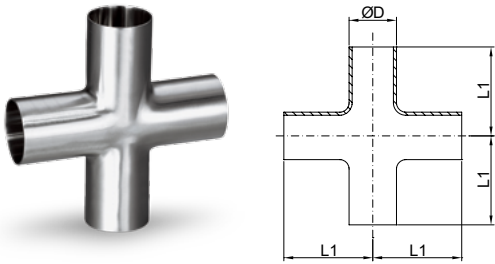

3A		No.KST-P018	
Size	D	L1	
1"	25.4	47.6	
1 1/2"	38.1	57.2	
2"	50.8	76.2	
2 1/2"	63.5	76.2	
3"	76.2	82.6	
4"	101.6	98.4	

卡箍式四通  
Clamped Cross

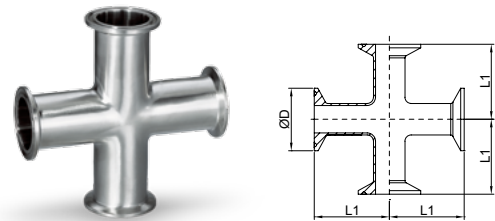

3A		No.KST-P019	
Size	D	L1	
1"	50.5	60.3	
1 1/2"	50.5	69.9	
2"	64.0	88.9	
2 1/2"	77.5	88.9	
3"	91.0	95.3	
4"	119.0	114.2	

焊接式四通  
Welded Cross

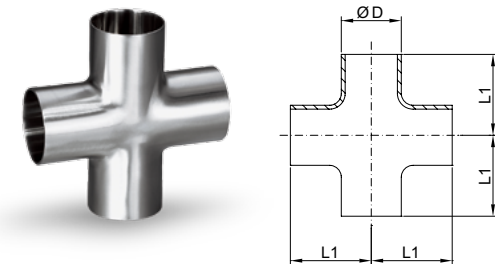

3A		No.KST-P020	
Size	D	L1	
1"	25.4	28.6	
1 1/2"	38.1	42.0	
2"	50.8	52.3	
2 1/2"	63.5	59.5	
3"	76.2	65.9	
4"	101.6	87.3	

焊接式三通  
Welded Tee

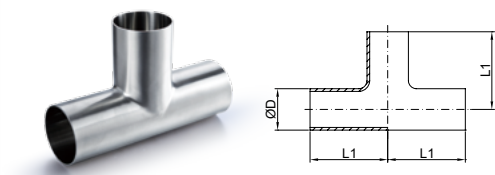

3A		No.KST-P021	
Size	D	L1	
		普通	加长
1"	25.4	28.6	47.6
1 1/2"	38.1	42	57.2
2"	50.8	52.3	76.2
2 1/2"	63.5	59.5	76.2
3"	76.2	65.9	82.6
4"	101.6	87.3	98.4
6"	152.4	127	143



卡箍式三通  
Clamped Tee

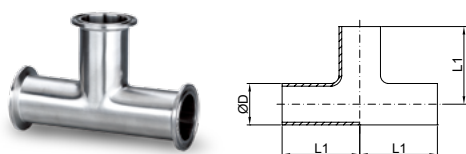

3A No.KST-P022

Size	B	L1
1"	50.5	60.3
1 1/2"	50.5	69.9
2"	64	88.9
2 1/2"	77.5	88.9
3"	91	95.3
4"	119	114.2

对焊 "Y" 型三通  
Butt weld Y-type Tee

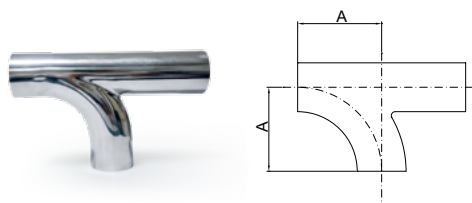

3A No.KST-P023

Size	A
1"	65.0
1 1/2"	85.0
2"	110.0
2 1/2"	135.0
3"	155.0
4"	195.0

对焊 "Y" 型三通  
Butt weld Y-type Tee

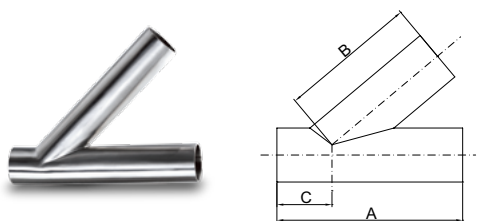

3A No.KST-P024

Size	A	B	C
1/2"	152.4	127.0	25.4
3/4"	152.4	127.0	25.4
1"	152.4	127.0	25.4
1 1/2"	187.3	173.1	30.2
2"	222.2	180.9	41.3
2 1/2"	254.0	215.9	38.1
3"	273.1	225.4	47.6
4"	325.5	273.1	52.4
6"	419.1	317.5	101.6

对焊 "Y" 型三通  
Butt weld Y-type Tee

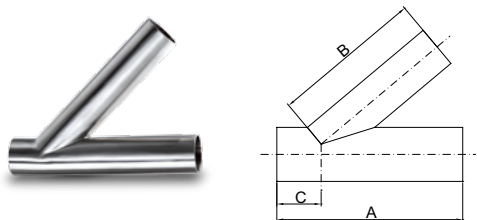

3A No.KST-P025

Size	A	B	C
1.5"-1.0"	187.3	157.2	30.2
2.0"-1.0"	222.2	181.0	41.3
2.0"-1.5"	222.2	181.0	41.3
2.5"-1.0"	254.0	215.9	38.1
2.5"-1.5"	254.0	215.9	38.1
2.5"-2.0"	254.0	215.9	38.1
3.0"-1.0"	273.1	225.4	47.6
3.0"-1.5"	273.1	225.4	47.6
3.0"-2.0"	273.1	225.4	47.6
3.0"-2.5"	273.1	225.4	47.6
4.0"-1.0"	325.5	273.1	52.4
4.0"-1.5"	325.5	273.1	52.4
4.0"-2.0"	325.5	273.1	52.4
4.0"-2.5"	325.5	273.1	52.4
4.0"-3.0"	325.5	273.1	52.4



# 卫生级管件(3A) SANITARY PIPE FITTINGS

对焊 "Y" 型三通  
Welded Y-type Tee

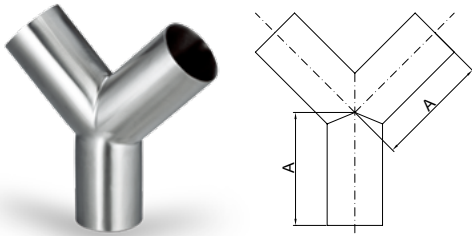

3A

No.KST-P026

Size	A
1/2	50.8
3/4	50.8
1	76.2
1 1/2	76.2
2	101.6
2 1/2	127.0
3	152.4
4	203.2
6	203.2

90°卡箍式双弯头  
90° Clamped Double Bend

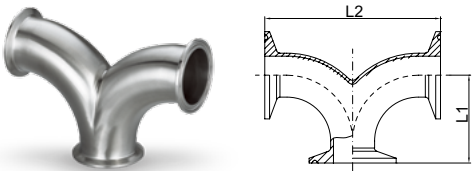

3A

No.KST-P027

Size	L1	L2
1"	50.8	101.6
1 1/2"	69.85	139.7
1 1/4"	60.4	120.8
2"	88.9	177.8
2 1/2"	107.9	215.9
3"	127.0	228.6
4"	168.4	336.8

卡箍式大小头  
Clamped Reducer

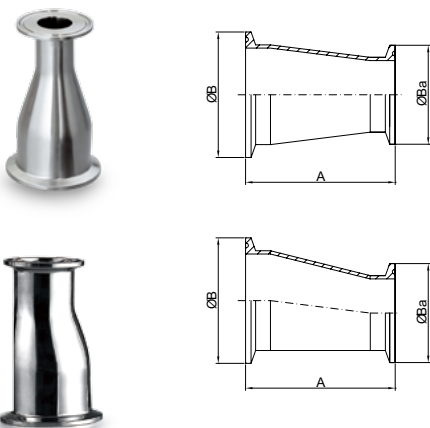

3A

No.KST-P028

Size	A	B	Ba
1.5"-1.0"	76.2	50.5	50.5
2.0"-1.0"	127	64	50.5
2.0"-1.5"	76.2	64	50.5
2.5"-1.0"	177.8	77.5	50.5
2.5"-1.5"	127	77.5	50.5
2.5"-2.0"	76.2	77.5	64
3.0"-1.0"	228.6	91	50.5
3.0"-1.5"	177.8	91	50.5
3.0"-2.0"	127	91	64
3.0"-2.5"	76.2	91	77.5
4.0"-1.0"	333.4	119	50.5
4.0"-1.5"	282.6	119	50.5
4.0"-2.0"	231.8	119	64
4.0"-2.5"	181	119	77.5
4.0"-3.0"	130.2	119	91
6.0"-4.0"	193.7	167	119

焊接式大小头短型  
Welded Reducer

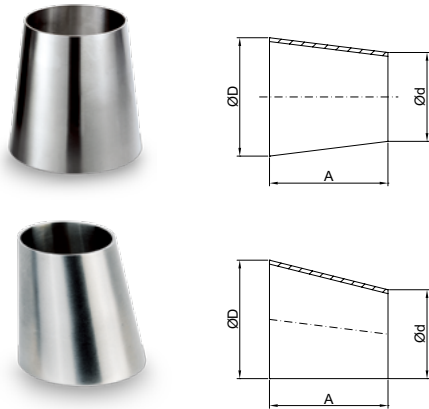

3A

No.KST-P029

Size	A	D	d
1.5"-1.0"	50.8	38.1	25.4
2.0"-1.0"	101.6	50.8	25.4
2.0"-1.5"	50.8	50.8	38.1
2.5"-1.5"	101.6	63.5	38.1
2.5"-2.0"	50.8	63.5	50.8
3.0"-1.5"	152.4	76.2	38.1
3.0"-2.0"	101.6	76.2	50.8
3.0"-2.5"	50.8	76.2	63.5
4.0"-2.0"	203.2	101.6	50.8
4.0"-2.5"	152.4	101.6	63.5
4.0"-3.0"	101.6	101.6	76.2
6.0"-3.0"	140	152.4	76.2
6.0"-4.0"	140	152.4	101.6

焊接式大小头加长型  
Welded Reducers (long Type)

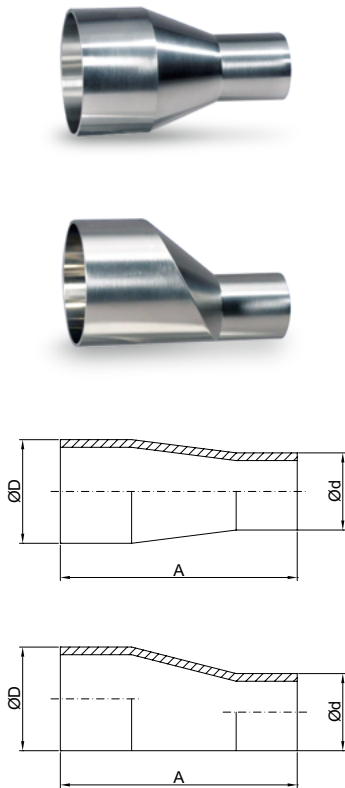

3A

No.KST-P030

Size	A	D	d
1/2"-1/4"	101.6	12.7	6.35
1/2"-3/8"	101.6	12.7	9.53
3/4"-3/8"	101.6	19.1	9.53
3/4"-1/2"	101.6	19.1	12.7
1.0"-3/8"	114.3	25.4	9.53
1.0"-1/2"	114.3	25.4	12.7
1.0"-3/4"	101.6	25.4	19.1
1.5"-1/2"	139.7	38.1	12.7
1.5"-3/4"	127	38.1	19.1
1.5"-1.0"	127	38.1	25.4
2.0"-1/2"	196	50.8	12.7
2.0"-3/4"	184.2	50.8	19.1
2.0"-1.0"	184.2	50.8	25.4
2.0"-1.5"	133.4	50.8	38.1
2.5"-1/2"	247.7	63.5	12.7
2.5"-3/4"	235	63.5	19.1
2.5"-1.0"	235	63.5	25.4
2.5"-1.5"	184.2	63.5	38.1
2.5"-2.0"	139.7	63.5	50.8
3.0"-1/2"	298.5	76.2	12.7
3.0"-3/4"	311.2	76.2	19.1
3.0"-1.0"	285.8	76.2	25.4
3.0"-1.5"	235	76.2	38.1
3.0"-2.0"	190.5	76.2	50.8
3.0"-2.5"	139.7	76.2	63.5
4.0"-1.0"	393.7	101.6	25.4
4.0"-1.5"	342.9	101.6	38.1
4.0"-2.0"	298.5	101.6	50.8
4.0"-2.5"	247.7	101.6	63.5
4.0"-3.0"	196.9	101.6	76.2
6.0"-4.0"	254	152.4	101.6

# 卫生级管件(SMS) SANITARY PIPE FITTINGS

90°焊接式弯头  
90° Welded Elbow

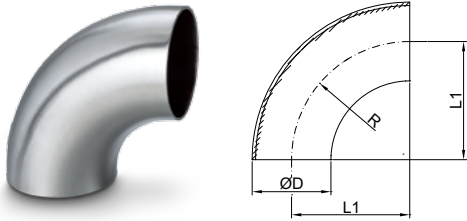

SMS

No.KST-P031

Size	D	L1	R
25	25.4	38.1	38.1
32	31.8	47.7	47.7
38	38.1	57.2	57.2
51	50.8	76.2	76.2
63	63.5	95.2	95.2
76	76.2	114.3	114.3
102	101.6	152.4	152.4

90°焊接式弯头长型  
90° Welded Elbow (Long Type)

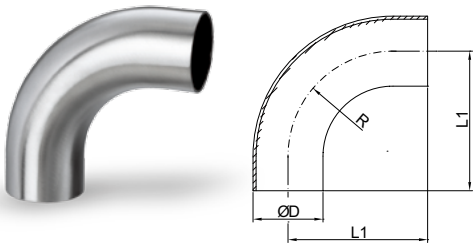

SMS

No.KST-P032

Size	D	L1	R
25	25.4	55.0	32.0
38	38.1	70.0	45.0
51	50.8	82.0	58.0
63	63.5	105.0	70.0
76	76.2	110.0	76.0
102	101.6	150.0	110.0

45°焊接式弯头  
45° Welded Elbow

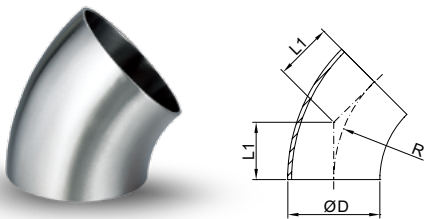

SMS

No.KST-P033

Size	D	L1	R
25	25.4	15.5	38.1
38	38.1	23.6	57.2
51	50.8	31.6	76.2
63	63.5	39.5	95.2
76	76.2	47.2	114.3
102	101.6	63.0	152.4

45°焊接式弯头长型  
45° Welded Elbow (Long Type)

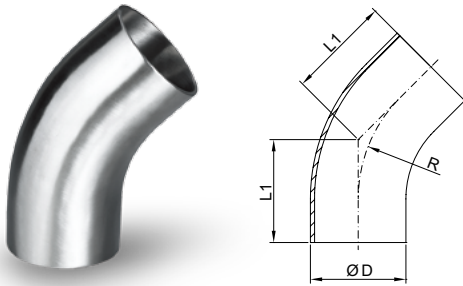

SMS

No.KST-P034

Size	D	L1	R
25	25.4	42.5	38.1
38	38.1	56.8	57.2
51	50.8	68.6	76.2
63	63.5	78.4	95.2
76	76.2	85.2	114.3
102	101.6	103.0	152.4

焊接式四通短型  
Welded Cross(short-type)

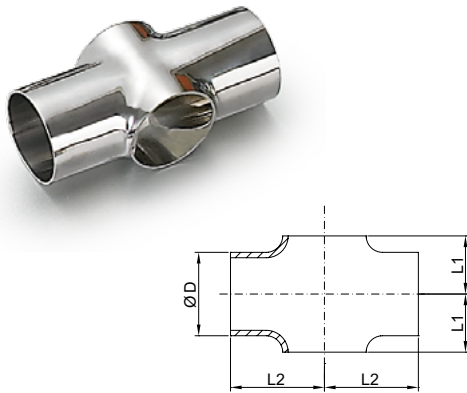

SMS

No.KST-P035

Size	D	L1	L2
25	25.4	15.0	55.0
38	38.1	21.5	70.0
51	50.8	29.0	82.0
63	63.5	36.0	105.0
76	76.2	43.0	110.0
102	101.6	57.0	150.0

焊接式三通短型  
Welded Tee(short-type)

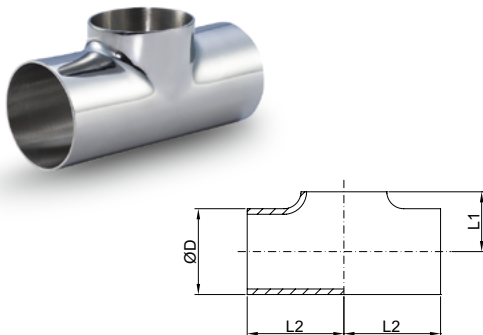

SMS

No.KST-P036

Size	D	L1	L2
25	25.4	15	55
38	38.1	21.5	70
51	50.8	29	82
63	63.5	36	105
76	76.2	43	110
102	101.6	57	150

# 卫生级管件(SMS) SANITARY PIPE FITTINGS

焊接式三通  
Welded Tee

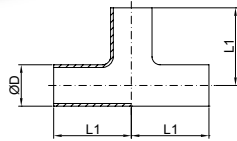

SMS			No.KST-P037
Size	D	L1	
25	25.4	55	
38	38.1	70	
51	50.8	82	
63	63.5	105	
76	76.2	110	
102	101.6	150	

单卡短出口三通  
Single Outlet Tee Short Clip

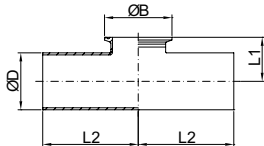

SMS					No.KST-P038
Size	D	B	L1	L2	
25	25.4	50.5	26.7	55	
38	38.1	50.5	33.7	70	
51	50.8	64	41.2	82	
63	63.5	91	48	105	
76	76.2	106	54.2	110	
102	101.6	119	70.5	150	
102	104	119	73.3	150	

变径焊接式三通  
Reducing Welded Tee

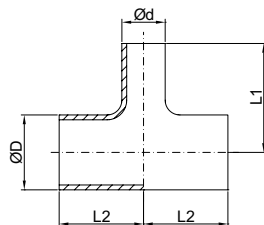

SMS						No.KST-P039
Size	D	d	L1	L2	T	
25-19	25	19.05	110	55	1.25	
38-19	38	19.05	140	70	1.25	
38-25	38	25	140	70	1.25	
51-25	51	25	164	82	1.25	
51-38	51	38	164	82	1.25	
63.5-25	63.5	25	210	105	1.5	
63.5-38	63.5	38	210	105	1.5	
63.5-51	63.5	51	210	105	1.5	
76.1-25	76.1	25	220	110	1.6	
76.1-38	76.1	38	220	110	1.6	
76.1-51	76.1	51	220	110	1.6	
76.1-63	76.1	63.5	220	110	1.6	
101.6-51	101.6	51	300	150	2	
101.6-63	101.6	63.5	300	150	2	
101.6-76	101.6	76.1	300	150	2	



### 焊接式大小头 Welded Reducer

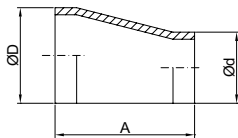
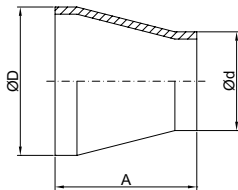

SMS

No.KST-P040

Size	A		D	d
	同心	偏心		
38-25	39	46	38	25
51-25	57	68	51	25
51-38	39	47	51	38
63.5-25	74	92	63.5	25
63.5-38	57	70	63.5	38
63.5-51	39	44	63.5	51
76.1-25	92	117	76.1	25
76.1-38	74	92	76.1	38
76.1-51	57	68	76.1	51
76.1-63	39	47	76.1	63.5
101-51	95	117	101.6	51
101-63	78	94	101.6	63.5
101-76	60	74	101.6	76.1
102-51	95	117	102	51
102-63	78	94	102	63.5
102-76	60	74	102	76.1

### 焊接式大小头加长型 Welded Reducers (Long Type)

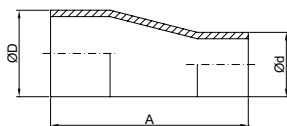
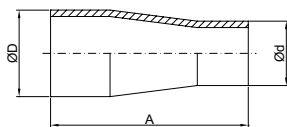
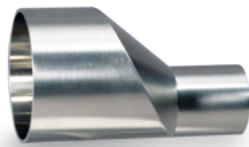

SMS

No.KST-P041

Size	A		D	d
	同心	偏心		
25-19	85	-	25	19.05
38-19	85	-	38	19.05
38-25	99	106	38	25
51-25	117	128	51	25
51-38	99	107	51	38
63.5-25	134	150.5	63.5	25
63.5-38	117	130	63.5	38
63.5-51	99	104	63.5	51
76.1-25	152	-	76.1	25
76.1-38	134	149	76.1	38
76.1-51	117	128	76.1	51
76.1-63	99	107	76.1	63.5
101-51	-	177	101.6	51
101-63	-	154	101.6	63.5
101-76	-	134	101.6	76.1
102-51	155	177	102	51
102-63	138	154	102	63.5
102-76	120	134	102	76.1

# 卫生级管件(DIN) SANITARY PIPE FITTINGS

90°焊接式弯头  
90° Welded Elbow

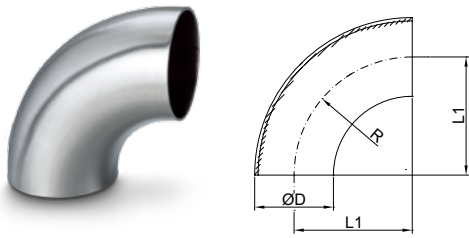

DIN

No.KST-P042

Size	D	L1	R
DN10	12.0	26.0	26.0
DN15	18.0	35.0	35.0
DN20	22.0	40.0	40.0
DN25	28.0	50.0	50.0
DN32	34.0	55.0	55.0
DN40	40.0	60.0	60.0
DN50	52.0	70.0	70.0
DN65	70.0	80.0	80.0
DN80	85.0	90.0	90.0
DN100	104.0	100.0	100.0
DN125	129.0	187.0	187.0
DN150	154.0	225.0	225.0
DN200	204.0	300.0	300.0
DN250	254.0	375.0	375.0
DN300	306.0	450.0	450.0

90°焊接式弯头长型  
90° Welded Elbow (Long type)

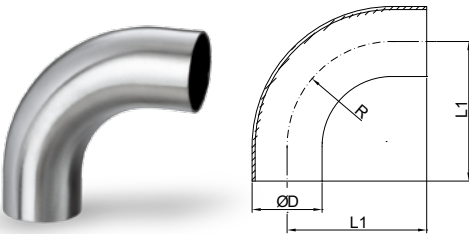

DIN

No.KST-P043

Size	D	L1	R
DN10	12.0	38.0	26.0
DN15	18.0	47.0	35.0
DN20	22.0	52.0	40.0
DN25	28.0	70.0	50.0
DN32	34.0	78.0	55.0
DN40	40.0	85.0	60.0
DN50	52.0	97.0	70.0
DN65	70.0	110.0	80.0
DN80	85.0	118.0	90.0
DN100	104.0	140.0	100.0

90°卡箍式弯头  
90° Clamped Elbow

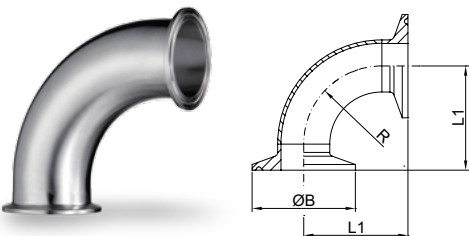

DIN

No.KST-P044

Size	B	L1	R
DN15	34.0	53.0	35.0
DN20	34.0	58.0	40.0
DN25	50.5	71.0	50.0
DN32	50.5	76.5	55.0
DN40	50.5	81.5	60.0
DN50	64.0	91.5	70.0
DN65	91.0	108.0	80.0
DN80	106.0	118.0	90.0
DN100	119.0	128.0	100.0

90°活接式弯头  
90° Union-type Elbow

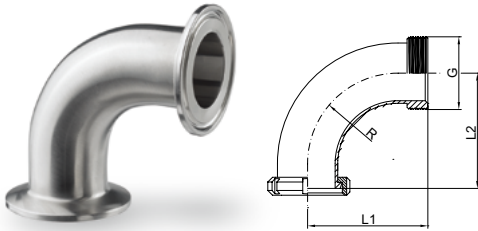

DIN No.KST-P045

Size	G	L1	L2	R
DN20	44×1/6	60.0	55.0	40.0
DN25	52×1/6	71.0	67.0	50.0
DN32	58×1/6	76.0	72.0	55.0
DN40	65×1/6	81.0	77.0	60.0
DN50	78×1/6	91.0	87.0	70.0
DN65	95×1/6	103.0	97.0	80.0
DN80	110×1/4	116.0	110.0	90.0
DN100	130×1/4	128.0	124.0	100.0

45°焊接式弯头  
45° Welded Elbow

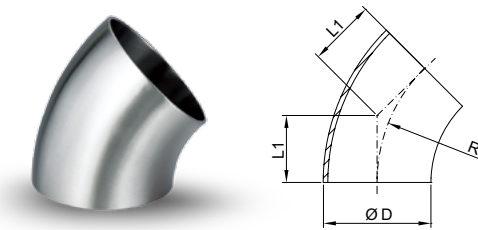

DIN No.KST-P046

Size	D	L1	R
DN10	12.0	10.7	26.0
DN15	18.0	14.5	35.0
DN20	22.0	16.5	40.0
DN25	28.0	20.7	50.0
DN32	34.0	22.8	55.0
DN40	40.0	24.8	60.0
DN50	52.0	29.0	70.0
DN65	70.0	33.2	80.0
DN80	85.0	37.3	90.0
DN100	104.0	41.5	100.0
DN125	129.0	77.5	187.0
DN150	154.0	93.2	225.0

45°卡箍式弯头  
45° Clamped Elbow

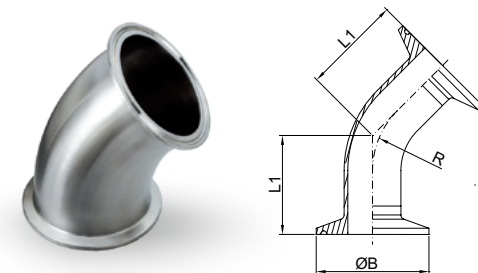

DIN No.KST-P047

Size	B	L1	R
20	34.0	34.5	40.0
25	50.5	42.2	50.0
32	50.5	44.3	55.0
40	50.5	46.3	60.0
50	64.0	50.5	70.0
65	91.0	61.2	80.0
80	106.0	65.3	90.0
100	119.0	69.5	100.0

# 卫生级管件(DIN) SANITARY PIPE FITTINGS

180°焊接式弯头  
180° Welded Elbow

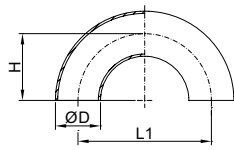

DIN

No.KST-P048

Size	D	L1	H
DN10	12.0	52.0	26.0
DN15	18.0	70.0	35.0
DN20	22.0	80.0	40.0
DN25	28.0	100.0	50.0
DN32	34.0	110.0	55.0
DN40	40.0	120.0	60.0
DN50	52.0	140.0	70.0
DN65	70.0	160.0	80.0
DN80	85.0	180.0	90.0
DN100	104.0	200.0	100.0
DN125	129.0	374.0	187.0
DN150	154.0	450.0	225.0

焊接式四通  
Welded Cross

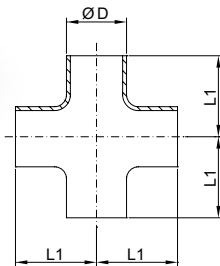

DIN

No.KST-P049

Size	D	L1
DN10	12.0	26.0
DN15	18.0	35.0
DN20	22.0	40.0
DN25	28.0	50.0
DN32	34.0	55.0
DN40	40.0	60.0
DN50	52.0	70.0
DN65	70.0	80.0
DN80	85.0	90.0
DN100	104.0	100.0
DN125	129.0	187.0
DN150	154.0	225.0
DN200	204.0	300.0
DN250	254.0	375.0
DN300	306.0	450.0

卡箍式四通  
Clamped Cross

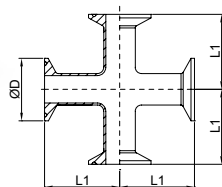

DIN

No.KST-P050

Size	D	L1
DN15	34.0	53.0
DN20	34.0	58.0
DN25	50.5	71.0
DN32	50.5	76.5
DN40	50.5	81.5
DN50	64.0	91.5
DN65	91.0	108.0
DN80	106.0	118.0
DN100	119.0	128.0

焊接式三通短型  
Welded Tee(short-type)

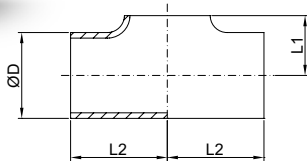

DIN

No.KST-P051

Size	D	L1	L2
DN10	12	7.5	26
DN15	18	10.5	35
DN20	22	12.5	40
DN25	28	16	50
DN32	34	19.5	55
DN40	40	22.5	60
DN50	52	30	70
DN65	70	39.5	80
DN80	85	47.5	90
DN100	104	58	100
DN125	129	70.5	187
DN150	154	83	225

焊接式三通  
Welded Tee(Long Type)

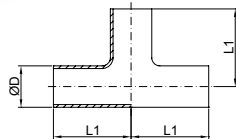

DIN

No.KST-P052

Size	D	L1
DN10	12	26
DN15	18	35
DN20	22	40
DN25	28	50
DN32	34	55
DN40	40	60
DN50	52	70
DN65	70	80
DN80	85	90
DN100	104	100
DN125	129	187
DN150	154	225

卡箍式三通  
Clamped Tee

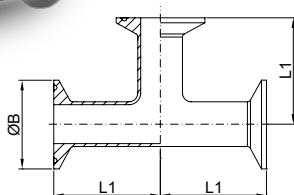

DIN

No.KST-P053

Size	B	L1
DN15	34	53
DN20	34	58
DN25	50.5	71
DN32	50.5	76.5
DN40	50.5	81.5
DN50	64	91.5
DN65	91	108
DN80	106	118
DN100	119	128

# 卫生级管件(DIN) SANITARY PIPE FITTINGS

## 焊接式大小头短型 Welded Reducer

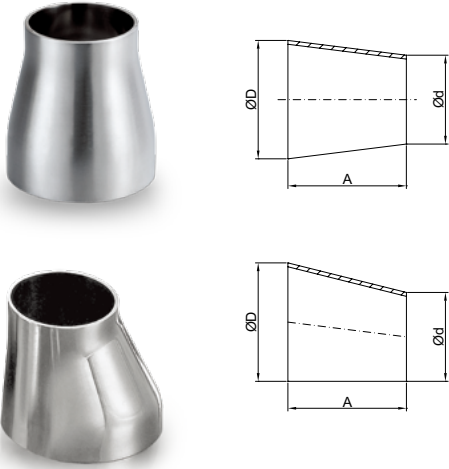

DIN

No.KST-P054

Size	A	D	d
DN20-15	7	22	18
DN25-20	11	28	22
DN32-20	22	34	22
DN32-25	11	34	28
DN40-20	33	40	22
DN40-25	22	40	28
DN40-32	11	40	34
DN50-25	44	52	28
DN50-32	33	52	34
DN50-40	22	52	40
DN65-25	73	70	28
DN65-32	62	70	34
DN65-40	51	70	40
DN65-50	29	70	52
DN80-40	78	85	40
DN80-50	56	85	52
DN80-65	27	85	70
DN100-50	90	104	52
DN100-65	61	104	70
DN100-80	34	104	85

## 焊接式大小头 Welded Reducer(Long Type)

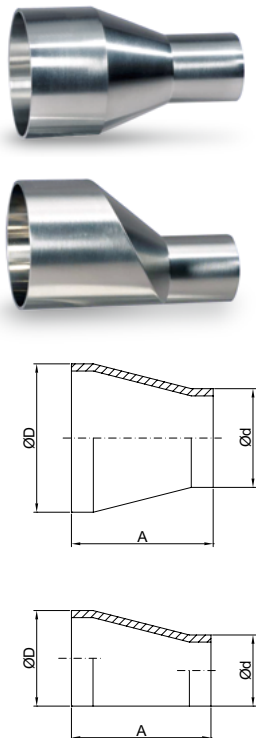

DIN

No.KST-P055

Size	A	D	d
DN20-15	60	22	18
DN25-20	60	28	22
DN32-20	80	34	22
DN32-25	80	34	28
DN40-20	102	40	22
DN40-25	102	40	28
DN40-32	102	40	34
DN50-25	115	52	28
DN50-32	115	52	34
DN50-40	115	52	40
DN65-25	125	70	28
DN65-32	125	70	34
DN65-40	120	70	40
DN65-50	120	70	52
DN80-40	140	85	40
DN80-50	125	85	52
DN80-65	120	85	70
DN100-50	160	104	52
DN100-65	127	104	70
DN100-80	120	104	85



卡箍式大小头  
Clamped Reducer

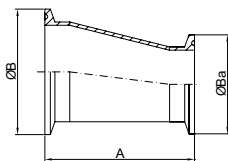
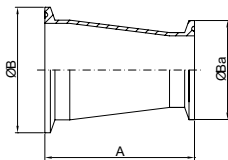

DIN

No.KST-P056

Size	A	B	Ba
DN20-15	86	34	34
DN25-20	86	50.5	34
DN32-20	106	50.5	34
DN32-25	106	50.5	50.5
DN40-20	128	50.5	34
DN40-25	128	50.5	50.5
DN40-32	128	50.5	50.5
DN50-25	141	64	50.5
DN50-32	141	64	50.5
DN50-40	141	64	50.5
DN65-25	151	91	50.5
DN65-32	151	91	50.5
DN65-40	146	91	50.5
DN65-50	146	91	64
DN80-40	166	106	50.5
DN80-50	151	106	64
DN80-65	146	106	91
DN100-50	192	119	64
DN100-65	159	119	91
DN100-80	152	119	106

由任式大小头  
Union-type Reducer

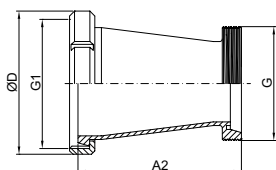
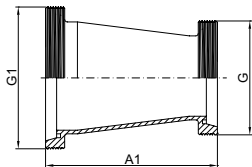

DIN

No.KST-P057

Size	D	A1	G	G1	A2
DN20-15	54	93	Rd34×1/8	Rd44×1/6	98
DN25-20	62	97	Rd44×1/6	Rd52×1/6	101
DN32-20	68	117	Rd44×1/6	Rd58×1/6	121
DN32-25	68	118	Rd52×1/6	Rd58×1/6	122
DN40-20	78	139	Rd44×1/6	Rd65×1/6	143
DN40-25	78	140	Rd52×1/6	Rd65×1/6	144
DN40-32	78	140	Rd58×1/6	Rd65×1/6	144
DN50-25	92	153	Rd52×1/6	Rd78×1/6	157
DN50-32	92	153	Rd58×1/6	Rd78×1/6	157
DN50-40	92	153	Rd65×1/6	Rd78×1/6	157
DN65-25	110	163	Rd52×1/6	Rd95×1/6	169
DN65-32	110	163	Rd58×1/6	Rd95×1/6	169
DN65-40	110	158	Rd65×1/6	Rd95×1/6	164
DN65-50	110	158	Rd78×1/6	Rd95×1/6	164
DN80-40	126	181	Rd65×1/6	Rd110×1/4	187
DN80-50	126	166	Rd78×1/6	Rd110×1/4	172
DN80-65	126	183	Rd95×1/6	Rd110×1/4	174
DN100-50	146	195	Rd78×1/6	Rd130×1/4	209
DN100-65	146	174	Rd95×1/6	Rd130×1/4	178
DN100-80	146	170	Rd110×1/4	Rd130×1/4	174

# 卫生级由任(ISO/IDF) SANITARY UNIONS

## 圆螺母 Round Nut

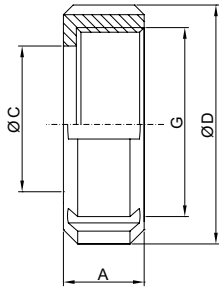

ISO/IDF

No.KST-U001

Size	A	C	D	G
1"	30	30.5	48	34.34×8TACME
1 1/2"	30	43.5	64	47.86×8TACME
2"	30	57	77	61.37×8TACME
2 1/2"	30	70.7	91	74.97×8TACME
3"	30	83.3	104	88.40×8TACME
4"ISO	30	110	135	119.40×8TACME
4"IDF	35	112	138	115.41×8TACME

## 六角螺母 Hexagon Nut

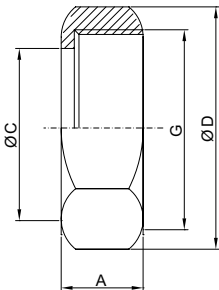

ISO/IDF

No.KST-U002

Size	A	C	D	G
1"	30	30.5	53.1	34.34×8TACME
1 1/2"	30	43.5	69.3	47.86×8TACME
2"	30	57	86.6	61.37×8TACME
2 1/2"	30	70.7	103.9	74.88×8TACME
3"	30	83.3	121.3	88.40×8TACME
4"ISO	30	110	155.9	119.40×8TACME
4"IDF	35	112	165.1	122.05×8TACME

## 螺纹接头 Threaded Liner

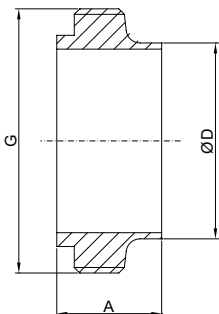

ISO/IDF

No.KST-U003

Size	D		A	G
	IDF	ISO		
1"	25.4	25.6	21.5	37.13×8TACME
1 1/2"	38.1	38.6	21.5	50.65×8TACME
2"	50.8	51.6	21.5	64.16×8TACME
2 1/2"	63.5	64.1	21.5	77.67×8TACME
3"	76.2	76.7	21.5	91.19×8TACME
4"ISO	-	102.5	21.5	118.4×8TACME
4"IDF	101.6	-	30	125.9×6TACME



膨胀型螺纹接头  
Expanded Male

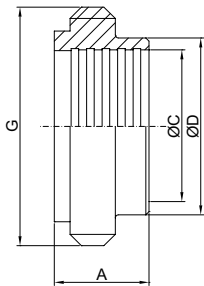

ISO/IDF	No.KST-U004			
Size	A	C	D	G
1"	16.5	25.5	29.2	37.13×8TACME
1 1/2"	19.5	38.2	42.7	50.65×8TACME
2"	19.5	50.9	56.2	64.16×8TACME
2 1/2"	25	63.6	69.9	77.67×8TACME
3"	30	76.3	82.6	91.19×8TACME
4"	35	101.7	111	125.9×6TACME

膨胀型平接头  
Expanded Liner

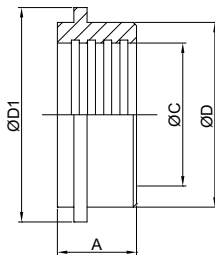

ISO/IDF	No.KST-U005			
Size	A	C	D	D1
1"	20.0	25.5	29.2	33.8
1 1/2"	20.0	38.2	42.7	47
2"	25.0	50.9	56.2	60.5
2 1/2"	30.0	63.6	69.9	74
3"	30.0	76.3	82.6	87.5
4"	30.0	101.7	111.0	120.6

平接头  
Liner

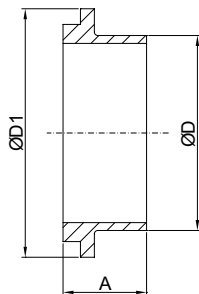

ISO/IDF	No.KST-U006			
Size	D		D	D1
	IDF	ISO		
1"	25.4	25.6	21.5	33.8
1 1/2"	38.1	38.6	21.5	47.0
2"	50.8	51.6	21.5	60.5
2 1/2"	63.5	64.1	21.5	74.0
3"	76.2	76.7	21.5	87.5
4"ISO	-	102.5	21.5	114.1
4"IDF	101.6	-	30	120.6

盲螺母  
Blind Cap

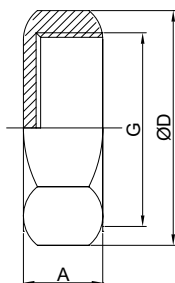

ISO/IDF	No.KST-U007		
Size	A	D	G
1"	30.0	46.0	38.3×8TACME
1 1/2"	30.0	60.0	51.8×8TACME
2"	30.0	75.0	65.3×8TACME
2 1/2"	30.0	90.0	78.8×8TACME
3"	30.0	105.0	92.3×8TACME
4 "ISO	30.0	135.0	119.4×8TACME
4 "IDF	35.0	143.0	127.2×8TACME

# 卫生级由任(3A) SANITARY UNIONS

## 六角螺母 Hexagon Nut

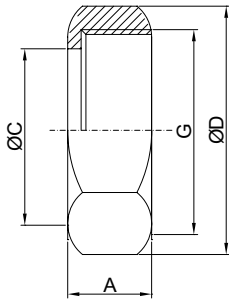

3A

No.KST-U008

Size	A	C	D	G
1"	23	30.3	46	38.02×1/8TACME
1 1/2"	24.6	43.4	61.1	51.54×1/8TACME
2"	27	56.5	76.2	62.05×1/8TACME
2 1/2"	29.6	69.6	91.3	78.56×1/8TACME
3"	32.5	82.7	106.4	92.08×1/8TACME
4"	38.1	108.9	137.6	120.14×1/6TACME

## 堵头 (16A) End Cap

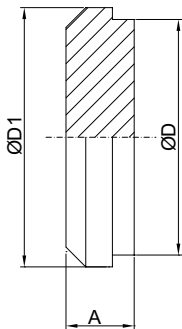

3A

No.KST-U009

Size	A	D	D1
1"	11.9	29.5	33.3
1 1/2"	14.3	42.6	46.8
2"	15.9	55.7	60.3
2 1/2"	16.7	68.8	73.8
3"	18.3	81.9	87.3
4"	20.6	108.1	114.3

## 螺纹式平接头 Threaded Liner

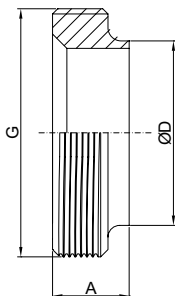

3A

No.KST-U010

Size	A		D	G
	15TRF	15A		
1"	18.3	34.9	25.4	37.13×1/8TACME
1 1/2"	18.3	38.1	38.1	50.65×1/8TACME
2"	19.1	38.1	50.8	64.1×1/8TACME
2 1/2"	22.2	44.5	63.5	77.67×1/8TACME
3"	23.1	44.5	76.2	91.19×1/8TACME
4"	26.2	44.5	101.6	119.25×1/6TACME

盲螺母  
Blind Cap

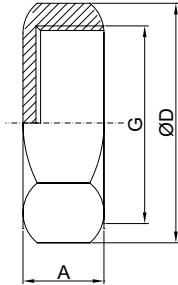

3A

No.KST-U011

Size	A	D	G
1"	23	52	38.02×1/8TACME
1 1/2"	24.6	70	51.54×1/8TACME
2"	27	88	62.05×1/8TACME
2 1/2"	29.6	105.5	78.56×1/8TACME
3"	32.5	123	92.08×1/8TACME
4"	38.1	159	120.14×1/6TACME

台阶式平接头  
Liner

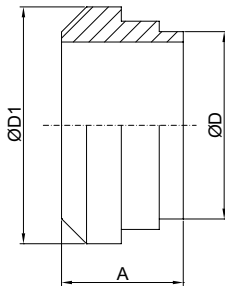

3A

No.KST-U012

Size	A		D	D1
	15TRF	15A		
1"	18.3	34.9	25.4	33.3
1 1/2"	18.3	38.1	38.1	46.8
2"	19.1	38.1	50.8	60.3
2 1/2"	22.2	44.5	63.5	73.8
3"	23.1	44.5	76.2	87.3
4"	26.2	44.5	101.6	114.3

膨胀型平接头  
Expanded Liner

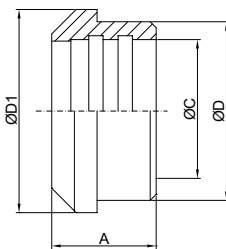

3A

No.KST-U013

Size	A	C	D	D1
1"	19.1	25.5	29.5	33.3
1 1/2"	28.6	38.2	42.6	46.8
2"	33.3	50.9	55.7	60.3
2 1/2"	34.9	63.6	68.8	73.8
3"	36.5	76.3	81.9	87.3
4"	38.1	101.7	108.1	114.3

# 卫生级由任(SMS) SANITARY UNIONS

圆螺母  
Hexagon Nut

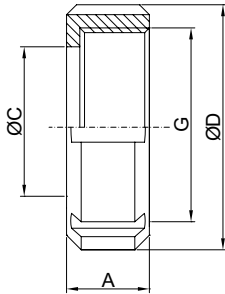

SMS

No.KST-U014

Size	A	C	D	G
19	18	25	44	Dd34×1/8
25	19	32	50	Dd40×1/6
32	21	40	60	Dd48×1/6
38	21	48	72	Dd60×1/6
51	22	60.5	82	Dd70×1/6
63	24	76	97	Dd85×1/6
76	26	87	111	Dd98×1/6
89	28	98.5	125	Dd110×1/6
102 小	28	112	138	Dd125×1/6
102 大	30	117	146	Dd132×1/6

圆螺母长型  
Round Nut(Long-type)

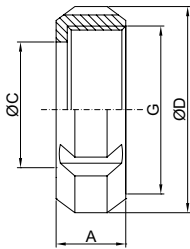

SMS

No.KST-U015

Size	A	C	D	G
25	20	32	50	Dd40×1/6
32	22	40	60	Dd48×1/6
38	22	48	72	Dd60×1/6
51	22	60.5	82	Dd70×1/6
63	25	76	97	Dd85×1/6
76	26	87	111	Dd98×1/6
102	30	117	146	Dd132×1/6

螺纹接头  
Male

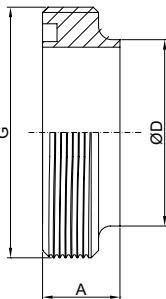

SMS

No.KST-U016

Size	A	D	G
19	16	19.1	Dd34×1/8
25	17	25.4	Dd40×1/6
32	18	31.8	Dd48×1/6
38	20	38.1	Dd60×1/6
51	20	50.8	Dd70×1/6
63	24	63.5	Dd85×1/6
76	25	76.2	Dd98×1/6
89	26	88.9	Dd110×1/6
102 小	27	101.6	Dd125×1/6
102 大	27	101.6	Dd132×1/6

带链条盲螺母  
Blind Cap with Chain

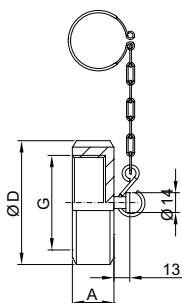

SMS

No.KST-U017

Size	A	D	G
19	18	44	Dd34×1/8
25	19	50	Dd40×1/6
32	21	60	Dd48×1/6
38	21	72	Dd60×1/6
51	22	82	Dd70×1/6
63	24	97	Dd85×1/6
76	26	111	Dd98×1/6
89	28	125	Dd110×1/6
102 小	28	138	Dd125×1/6
102 大	30	146	Dd132×1/6



螺纹接头长型  
Male(Long-type)

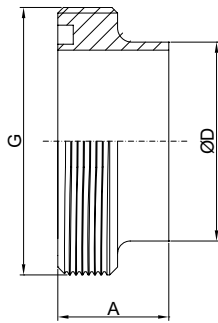

SMS

No.KST-U018

Size	A	D	G
25	19	25.4	Dd40×1/6
38	23	38.1	Dd60×1/6
51	23	50.8	Dd70×1/6
63	27	63.5	Dd85×1/6
76	27	76.2	Dd98×1/6
102 小	27	101.6	Dd125×1/6
102 大	30	101.6	Dd132×1/6

膨胀型平接头  
Expanded Liner

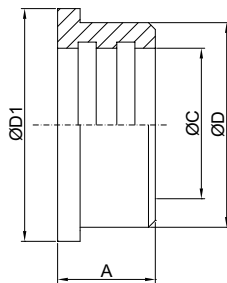

SMS

No.KST-U019

Size	A	D	D1	C
19	24	25	30	19.2
25	17	31.5	35	25.5
32	17	38	43	31.9
38	20	46	55	38.2
51	20	59	65	50.9
63	25	72	80	63.6
76	25	85	93	76.3
89	27	98	105	89
102 小	30	112	120.5	101.7
102 大	30	112	127.5	101.7

圆弧式平接头  
Circular Liner

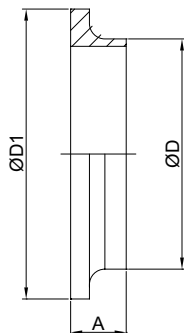

SMS

No.KST-U020

Size	A	D	D1
19	11	19.1	30.8
25	12	25.4	35.7
32	12	31.8	43.7
38	12	38.1	55.7
51	12	50.8	65.7
63	14	63.5	80.7
76	14	76.2	93.5
89	14	88.9	105.5
102 小	17	101.6	120.5
102 大	17	101.6	127.5

# 卫生级由任(SMS) SANITARY UNIONS

## 膨胀型螺纹接头 Expanded Male

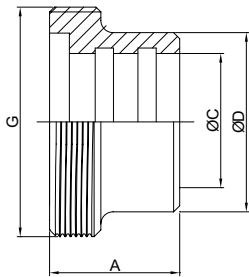

SMS

No.KST-U021

Size	A	D	C	G
19	20	25	19.2	Rd34×1/8
25	20	31.5	25.5	Rd40×1/6
32	20	38	31.9	Rd48×1/6
38	23	46	38.2	Rd60×1/6
51	25	59	50.9	Rd70×1/6
63	30	72	63.6	Rd85×1/6
76	30	85	76.3	Rd98×1/6
89	32	98	89	Rd110×1/6
102 小	35	112	101.7	Rd125×1/6
102 大	35	112	101.7	Rd132×1/6

## 台阶式平接头 Stepped Liner

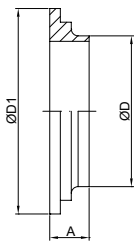

SMS

No.KST-U022

Size	A	D	D1
19	11	19.1	30.8
25	12	25.4	35.7
32	12	31.8	43.7
38	12	38.1	55.7
51	12	50.8	65.7
63	14	63.5	80.7
76	14	76.2	93.5
89	14	88.9	105.5
102 小	17	101.6	120.5
102 大	17	101.6	127.5

## 圆弧式平接头长型 Circular Liner(Long-type)

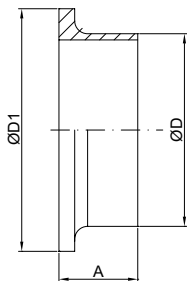

SMS

No.KST-U023

Size	A	D	D1
25	15	25.4	35.5
38	20	38.1	55.5
51	20	50.8	65.5
63	21	63.5	80.5
76	21	76.2	93.8
102 小	21	101.6	118
102 大	21	101.6	127.8

## 台阶式平接头长型 Stepped Liner(Long-type)

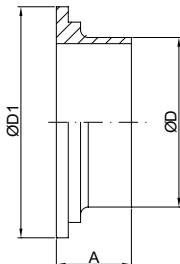

SMS

No.KST-U024

Size	A	D	D1
25	15	25.4	35.5
38	20	38.1	55.5
51	20	50.8	65.5
63	21	63.5	80.5
76	21	76.2	93.8
102 小	21	101.6	118
102 大	21	101.6	127.8

# 卫生级由任(DIN) SANITARY UNIONS

www.cnkingstone.com www.china-kst.com



## 圆螺母 Round Nut

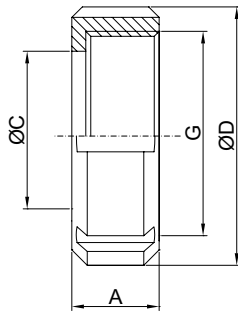

DIN	No.KST-U025			
Size	A	C	D	G
DN10	18	19	38	Dd28×1/8
DN15	18	25	44	Dd34×1/8
DN20	20	31	54	Dd44×1/6
DN25	21	36	63	Dd52×1/6
DN32	21	42	70	Dd58×1/6
DN40	21	49	78	Dd65×1/6
DN50	22	62	92	Dd78×1/6
DN65	25	80	112	Dd95×1/6
DN80	29	94	127	Dd110×1/4
DN100	31	115	148	Dd130×1/4
DN125	35	138	178	Dd160×1/4
DN150	40	164	208	Dd190×1/4

## 带链条盲螺母 Blind Cap with Chain

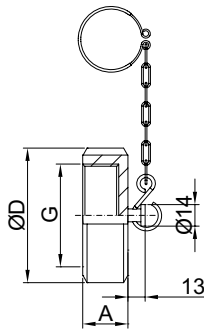

DIN	No.KST-U026		
Size	A	D	G
DN15	18	44	Dd34×1/8
DN20	19	54	Dd44×1/6
DN25	21	63	Dd52×1/6
DN32	21	70	Dd58×1/6
DN40	21	78	Dd65×1/6
DN50	22	92	Dd78×1/6
DN65	24	112	Dd95×1/6
DN80	28	127	Dd110×1/4
DN100	30	148	Dd130×1/4
DN125	32	178	Dd160×1/4
DN150	34	208	Dd190×1/4

## 螺纹接头 Male

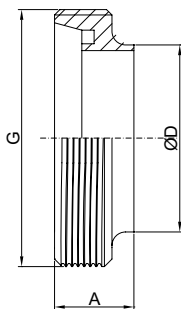

DIN	No.KST-U027		
Size	A	D	G
DN15	17	19	Dd34×1/8
DN20	19	23	Dd44×1/6
DN25	20	29	Dd52×1/6
DN32	20	35	Dd58×1/6
DN40	20	41	Dd65×1/6
DN50	21	53	Dd78×1/6
DN65	23	70	Dd95×1/6
DN80	27	85	Dd110×1/4
DN100	28	104	Dd130×1/4
DN125	31	129	Dd160×1/4
DN150	35	154	Dd190×1/4

# 卫生级由任(DIN) SANITARY UNIONS

## 膨胀型平接头 Expanded Liner

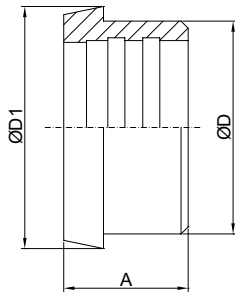

DIN

No.KST-U028

Size	A	D	D1
DN10	17	18	22
DN15	17	24	28
DN20	18	30	36
DN25	22	35	44
DN32	25	41	50
DN40	26	48	56
DN50	28	61	68
DN65	32	79	86
DN80	37	93	100
DN100	44	114	121
DN125	34	137	150
DN150	37	163	176

## 螺纹接头长型 Long Male(Long-type)

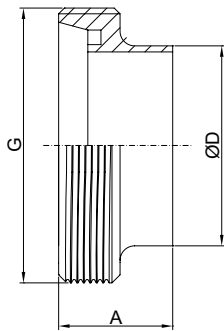

DIN

No.KST-U029

Size	A	D	G
DN10	21	13	Dd28×1/8
DN15	21	19	Dd34×1/8
DN20	24	23	Dd44×1/6
DN25	29	29	Dd52×1/6
DN32	32	35	Dd58×1/6
DN40	33	41	Dd65×1/6
DN50	35	53	Dd78×1/6
DN65	40	70	Dd95×1/6
DN80	45	85	Dd110×1/4
DN100	54	104	Dd130×1/4
DN125	46	129	Dd160×1/4
DN150	50	154	Dd190×1/4

## 膨胀型螺纹接头 Expanded Male

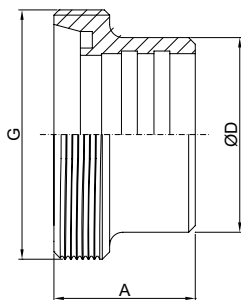

DIN

No.KST-U030

Size	A	D	D1	G
DN10	21	18	22	Dd28×1/8
DN15	21	24	28	Dd34×1/8
DN20	24	30	36	Dd44×1/6
DN25	29	35	44	Dd52×1/6
DN32	32	41	50	Dd58×1/6
DN40	33	48	56	Dd65×1/6
DN50	35	61	68	Dd78×1/6
DN65	40	79	86	Dd95×1/6
DN80	45	93	100	Dd110×1/4
DN100	54	114	121	Dd130×1/4
DN125	46	137	150	Dd160×1/4
DN150	50	163	176	Dd190×1/4

平接头  
Liner

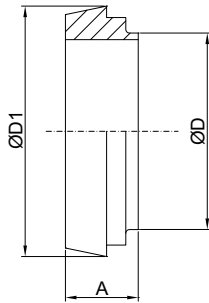

DIN	Size	A	D	D1	No.KST-U031
	DN10		13	22	
	DN15	13	19	28	
	DN20	15	23	36	
	DN25	17	29	44	
	DN32	17	35	50	
	DN40	19	41	56	
	DN50	20	53	68	
	DN65	20	70	86	
	DN80	23	85	100	
	DN100	26	104	121	
	DN125	33	129	150	
	DN150	34	154	176	

盲板  
Blank Cap

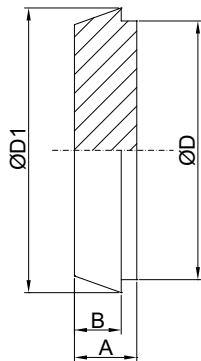

DIN	Size	A	B	D	D1	No.KST-U032
	DN10	9	6	18	22	
	DN15	9	6	24	28	
	DN20	11	8	30	36	
	DN25	13	10	35	44	
	DN32	13	10	41	50	
	DN40	13	10	48	56	
	DN50	14	11	61	68	
	DN65	16	12	79	86	
	DN80	16	12	93	100	
	DN100	20	15	114	121	
	DN125	22	17	137	150	
	DN150	24	18	163	176	

平接头长型  
Long Liner

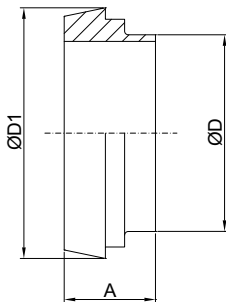

DIN	Size	A	D	D1	No.KST-U033
	DN10	17	13	22	
	DN15	17	19	28	
	DN20	18	23	36	
	DN25	22	29	44	
	DN32	25	35	50	
	DN40	26	41	56	
	DN50	28	53	68	
	DN65	32	70	86	
	DN80	37	85	100	
	DN100	44	104	121	
	DN125	34	129	150	
	DN150	37	154	176	

# 由任密封圈 SANITARY UNIONS

## 由任垫圈 Gasket for UNION

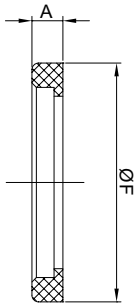

DIN

No.KST-U034

Size	A	F
DN15	5.0	26.0
DN20	5.0	33.0
DN25	5.0	40.0
DN32	5.0	46.0
DN40	5.0	52.0
DN50	5.0	64.0
DN65	5.0	81.0
DN80	6.0	95.0
DN100	6.0	114.0
DN125	7.0	142.0
DN150	7.0	167.0

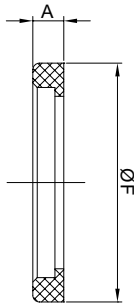

SMS

No.KST-U035

Size	A	F
25	5.5	33.0
32	5.5	40.0
38	5.5	48.0
51	5.5	61.0
63	5.5	73.0
76	6.0	86.0
89	6.0	99.0
102	6.0	114.0

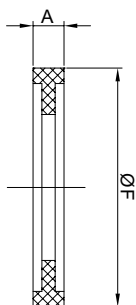

ISO

No.KST-U036

Size	A	F
1"	7.0	32.5
1 1/2"	7.0	46.0
2"	7.0	59.5
2 1/2"	7.0	73.0
3"	7.0	86.5
4 "ISO	7.0	119.0



# 卫生级卡箍接头 SANITARY FERRULE

www.cnkingstone.com www.china-kst.com



## 焊接式软管接头 Welded Hose Nipple

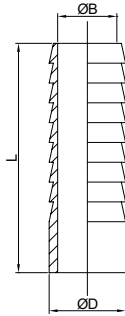

3A

No.KST-F001

Size	B	D	L
1/2"	9.0	12.7	38.1
3/4"	15.0	19.1	38.1
1"	21.4	25.4	101.6
1 1/4"	27.8	31.8	101.6
1 1/2"	34.0	38.1	101.6
2"	47.0	50.8	101.6
2 1/2"	59.5	63.5	101.6
3"	72.2	76.2	101.6
4"	97.6	101.6	98.4

## 卡箍式软管接头 Clamped Hose coupling

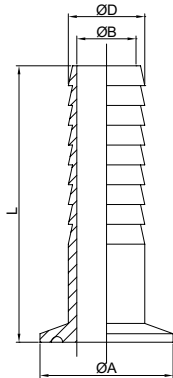

3A

No.KST-F002

Size	A	B	D	L
1/2"	25.2	9.0	12.7	50.8
3/4"	25.2	15.0	19.1	50.8
1"	50.5	21.4	25.4	114.3
1 1/4"	50.5	27.8	31.8	114.3
1 1/2"	50.5	34.0	38.1	114.3
2"	64.0	47.0	50.8	114.3
2 1/2"	77.5	59.5	63.5	114.3
3"	91.0	72.2	76.2	114.3
4"	119.0	97.6	101.6	114.3

## 由任式软管接头 Union-type Hose coupling

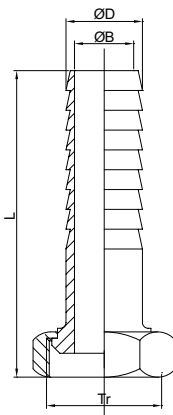

3A

No.KST-F003

Size	B	D	Tr	L
1"	21.4	25.4	38.02×1/8TACME	119.9
1 1/2"	34.0	38.1	51.54×1/8TACME	119.9
2"	47.0	50.8	62.05×1/8TACME	120.7
2 1/2"	59.5	63.5	78.56×1/8TACME	123.9
3"	72.2	76.2	92.08×1/8TACME	124.7
4"	97.6	101.6	120.14×1/6TACME	124.7

# 卫生级卡箍接头 SANITARY FERRULE

## 外螺适配器 Male adapter

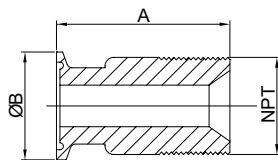

1/2"X3/8"-3/4"X3/4"

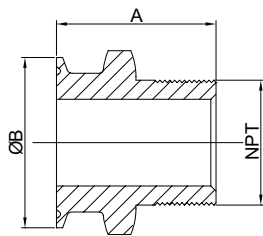

1.0"X1/2"-4.0"X4.0"

21MP

No.KST-F004

Size	A	B	NPT
1/2"×1/8"	50.8	25.2	1/8"NPT
1/2"×1/4"	50.8	25.2	1/4"NPT
1/2"×3/8"	50.8	25.2	3/8"NPT
1/2"×1/2"	50.8	25.2	1/2"NPT
1/2"×3/4"	50.8	25.2	3/4"NPT
3/4"×1/8"	50.8	25.2	1/8"NPT
3/4"×1/4"	50.8	25.2	1/4"NPT
3/4"×3/8"	50.8	25.2	3/8"NPT
3/4"×1/2"	50.8	25.2	1/2"NPT
3/4"×3/4"	50.8	25.2	3/4"NPT
1.0"×1/2"	55.6	50.5	1/2"NPT
1.0"×3/4"	55.6	50.5	3/4"NPT
1.0"×1.0"	57.0	50.5	1.0"NPT
1.0"×1 1/4"	62.0	50.5	1 1/4"NPT
1.0"×1 1/2"	62.0	50.5	1 1/2"NPT
1.0"×2.0"	66.7	50.5	2.0"NPT
1 1/2"×1/2"	55.6	50.5	1/2"NPT
1 1/2"×3/4"	55.6	50.5	3/4"NPT
1 1/2"×1.0"	58.7	50.5	1.0"NPT
1 1/2"×1 1/4"	62.0	50.5	1 1/4"NPT
1 1/2"×1 1/2"	62.0	50.5	1 1/2"NPT
1 1/2"×2.0"	66.7	50.5	2.0"NPT
2.0"×1/2"	57.0	64	1/2"NPT
2.0"×3/4"	58.0	64	3/4"NPT
2.0"×1.0"	62.7	64	1.0"NPT
2.0"×1 1/4"	62.7	64	1 1/4"NPT
2.0"×1 1/2"	62.7	64	1 1/2"NPT
2.0"×2.0"	67.5	64	2.0"NPT
2.0"×2 1/2"	79.3	64	2 1/2"NPT
2 1/2"×1.0"	70.6	77.5	1.0"NPT
2 1/2"×1 1/2"	70.6	77.5	1 1/2"NPT
2 1/2"×2.0"	70.6	77.5	2.0"NPT
2 1/2"×2 1/2"	83.3	77.5	2 1/2"NPT
3.0"×2 1/2"	88.9	91	2 1/2"NPT
3.0"×3.0"	88.9	91	3.0"NPT
4.0"×2.0"	96.8	119	2.0"NPT
4.0"×3.0"	122.2	119	3.0"NPT
4.0"×4.0"	96.8	119	4.0"NPT



内螺适配器  
Female adapter

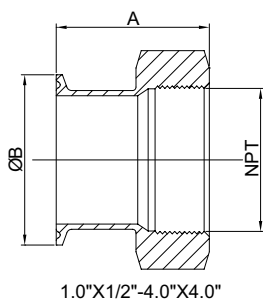
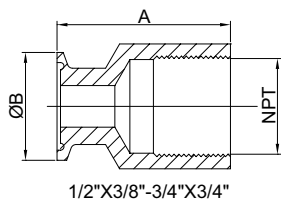

21MP

No.KST-F005

Size	A	B	NPT
1/2"×1/8"	31.7	25.2	1/8"NPT
1/2"×1/4"	38.1	25.2	1/4"NPT
1/2"×3/8"	38.1	25.2	3/8"NPT
1/2"×1/2"	38.1	25.2	1/2"NPT
1/2"×3/4"	41.3	25.2	3/4"NPT
3/4"×1/8"	31.7	25.2	1/8"NPT
3/4"×1/4"	38.1	25.2	1/4"NPT
3/4"×3/8"	38.1	25.2	3/8"NPT
3/4"×1/2"	38.1	25.2	1/2"NPT
3/4"×3/4"	41.3	25.2	3/4"NPT
1.0"×1/2"	41.3	50.5	1/2"NPT
1.0"×3/4"	41.3	50.5	3/4"NPT
1.0"×1.0"	41.3	50.5	1.0"NPT
1.0"×1 1/4"	57.2	50.5	1 1/4"NPT
1.0"×1 1/2"	57.2	50.5	1 1/2"NPT
1.0"×2.0"	41.3	50.5	2.0"NPT
1 1/2"×1/2"	41.3	50.5	1/2"NPT
1 1/2"×3/4"	41.3	50.5	3/4"NPT
1 1/2"×1.0"	41.3	50.5	1.0"NPT
1 1/2"×1 1/4"	57.2	50.5	1 1/4"NPT
1 1/2"×1 1/2"	57.2	50.5	1 1/2"NPT
1 1/2"×2.0"	57.2	50.5	2.0"NPT
2.0"×1/2"	42.9	64	1/2"NPT
2.0"×3/4"	42.9	64	3/4"NPT
2.0"×1.0"	42.9	64	1.0"NPT
2.0"×1 1/4"	42.9	64	1 1/4"NPT
2.0"×1 1/2"	62.7	64	1 1/2"NPT
2.0"×2.0"	59.5	64	2.0"NPT
2.0"×2 1/2"	61.1	64	2 1/2"NPT
2 1/2"×1.0"	33.3	77.5	1.0"NPT
2 1/2"×1 1/2"	42.0	77.5	1 1/2"NPT
2 1/2"×2.0"	43.7	77.5	2.0"NPT
2 1/2"×2 1/2"	43.7	77.5	2 1/2"NPT
3.0"×2 1/2"	55.6	91	2 1/2"NPT
3.0"×3.0"	55.6	91	3.0"NPT
4.0"×2.0"	55.6	119	2.0"NPT
4.0"×3.0"	55.6	119	3.0"NPT
4.0"×4.0"	66.7	119	4.0"NPT

# 卫生级卡箍接头 SANITARY FERRULE

卡箍垫圈  
Gasket for ferrule

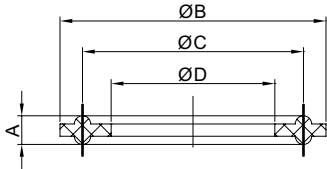

DIN

No.KST-F006

Size	A	B	C	D
DN15	5.0	34	27.5	15
DN20	5.0	34	27.5	19
DN25	5.0	50.5	43.5	25
DN32	5.5	50.5	43.5	31
DN40	5.5	50.5	43.5	37
DN50	5.5	64.0	56.5	49
DN65	5.5	91.0	83.5	66
DN80	5.5	106.0	97	81
DN100	5.5	119.0	110	100
DN125	5.5	145.0	135	125
DN150	5.5	167.0	160	150

卡箍垫圈  
Gasket for ferrule

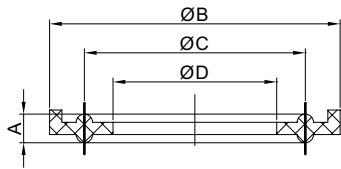

SMS

No.KST-F007

Size	A	B	C	D
1"	5.0	52.7	43.5	22.1
1 1/2"	5.0	52.7	43.5	34.8
2"	5.5	66.2	56.5	47.8
2 1/2"	5.5	79.7	70.5	60.2
3"	5.5	93.2	83.5	72.9
4"	5.5	121.2	110	97.4

卡箍垫圈  
Gasket for ferrule

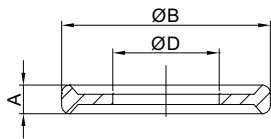

3A

No.KST-F008

Size	A	B	D
1/2"	4.5	21.8	9.7
3/4"	4.5	21.8	15.7

卡箍垫圈  
Gasket for ferrule

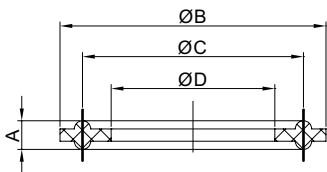

3A

No.KST-F009

Size	A	B	C	D
1"	5.0	50.5	43.5	22.1
1 1/2"	5.0	50.5	43.5	34.8
2"	5.5	64.0	56.5	47.5
2 1/2"	5.5	77.5	70.5	60.2
3"	5.5	91	83.5	72.9
4"	5.5	119	110	97.4
6"	5.5	167	160	146.7
8"	5.5	217.7	210	197.5
10"	5.5	268.5	260	248.3



卡箍接头  
Ferrule

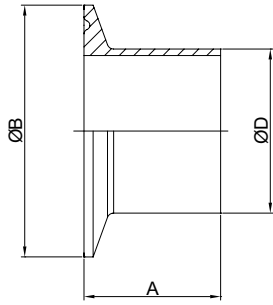

DIN

No.KST-F010

Size	A	B	D
DN10	18.0	34.0	12.0
DN15	18.0	34.0	18.0
DN20	18.0	34.0	22.0
DN25	21.5	50.5	28.0
DN32	21.5	50.5	34.0
DN40	21.5	50.5	40.0
DN50	28.0	64.0	52.0
DN65	28.0	91.0	70.0
DN80	28.0	106.0	85.0
DN100	28.0	119.0	104.0
DN125	38.0	145.0	129.0
DN150	38.0	167.0	154.0

卡箍接头  
Ferrule

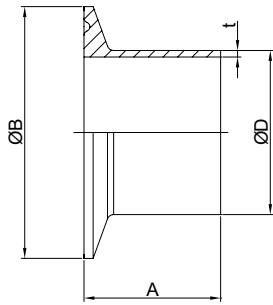

SMS

No.KST-F011

Size	A	B	D	t	t
Φ12	21.5	25.4	12.7	1.25	1.5
Φ19	21.5	50.5	19.1	1.25	1.5
Φ25	21.5	50.5	25.4	1.25	1.5
Φ32	21.5	50.5	31.8	1.25	1.5
Φ38	21.5	50.5	38.1	1.25	1.5
Φ51	21.5	64.0	50.8	1.25	1.5
Φ63	21.5	77.5	63.5	1.25	2.0
Φ76	21.5	91.0	76.2	1.5	2.0
Φ89	21.5	106.0	89.0	2.0	2.0
Φ102	21.5	119.0	101.6	2.0	2.0

卡箍接头  
Ferrule

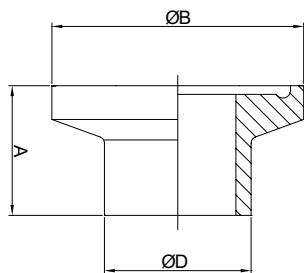

3A

No.KST-F012

Size	A	B	D
14WMP	1/2"	12.7	25.2
	3/4"	12.7	25.2
14MMP	1/2"	21.5	25.2
	3/4"	21.5	25.2
14AMP	1/2"	28.6	25.2
	3/4"	28.6	25.2
14AMP-AWF(BPE)	1/2"	44.5	25.2
	3/4"	44.5	25.2

# 卫生级卡箍接头 SANITARY FERRULE

卡箍接头  
Ferrule

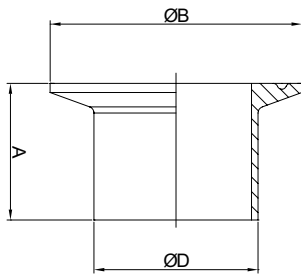

3A

No.KST-F013

Size	A			B	D
	14WMP	14MMP	14AMP		
1"	12.7	21.5	28.6	50.5	25.4
1 1/2"	12.7	21.5	28.6	50.5	38.1
2"	12.7	21.5	28.6	64.0	50.8
2 1/2"	12.7	21.5	28.6	77.5	63.5
3"	12.7	21.5	28.6	91.0	76.2
4"	15.8	21.5	28.6	119.0	101.6
6"	22.2	21.5	38.1	167.0	152.4
8"	22.2	21.5	38.1	217.7	203.2
10"	22.2	21.5	38.1	268.5	254.0

卡箍接头  
Ferrule

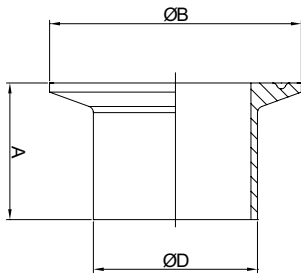

ISO/IDF

No.KST-F014

Size	A	B	D
1"	21.5	50.5	25.4
1 1/4"	21.5	50.5	31.8
1 1/2"	21.5	50.5	38.1
2"	21.5	64.0	50.8
2 1/2"	21.5	77.5	63.5
3"	21.5	91.0	76.2
3 1/2"	21.5	106.0	88.9
4"	21.5	119.0	101.6

卡箍接头  
Ferrule

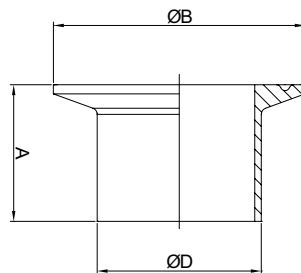

BPE

No.KST-F015

Size	A	B	D
1/2"	44.5	25.4	12.7
3/4"	44.5	25.4	19.1
1"	44.5	50.5	25.4
1 1/2"	44.5	50.5	38.1
2"	57.2	64.0	50.8
2 1/2"	57.2	77.5	63.5
3"	57.2	91.0	76.2
4"	57.2	119.0	101.6



卡箍堵头  
End Cap

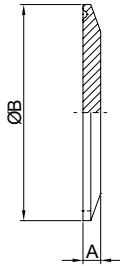

DIN		No.KST-F016	
Size	A	B	
DN10	6.3	34.0	
DN15	6.3	34.0	
DN20	6.3	34.0	
DN25	6.3	50.5	
DN32	6.3	50.5	
DN40	6.3	50.5	
DN50	6.3	64.0	
DN65	6.3	91.0	
DN80	6.3	106.0	
DN100	6.3	119.0	
DN125	11.1	145.0	
DN150	11.1	167.0	

卡箍堵头  
(16AMP) End Cap

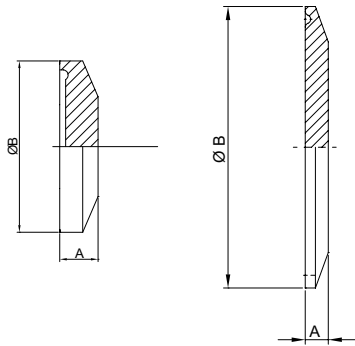

		No.KST-F017	
Size	A	B	
1/2"	6.3	25.2	
3/4"	6.3	25.2	
1"	6.3	50.5	
1 1/2"	6.3	50.5	
2"	6.3	64.0	
2 1/2"	6.3	77.5	
3"	6.3	91.0	
4"	7.9	119.0	
6"	11.1	167.0	
8"	11.1	217.7	
10"	11.1	268.5	

扩展式接头  
(14RMP) Expanded Ferrule

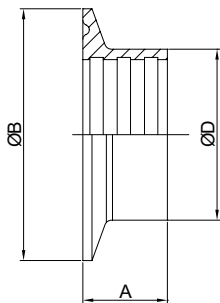

		No.KST-F018		
Size	A	B	D	
1"	19.1	50.5	29.5	
1 1/2"	28.6	50.5	42.6	
2"	33.3	64.0	55.7	
2 1/2"	34.9	77.5	68.8	
3"	36.5	91.0	81.9	
4"	38.1	119.0	108.1	

# 卫生级卡箍接头 SANITARY FERRULE



双销卡箍  
Double pin clamp 13SFLiner

No.KST-F019

材质：AIS I304  
管道流量控制：Φ12.7-305 及 1/2"-12"  
Material：AISI304  
Flux domination of pipeline：Φ12.7-305 & 1/2"-12"

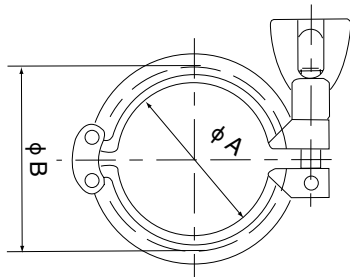

SIZE	ΦA	ΦB
1/2 "-3/4"	20	28
A37	27.5	42.9
1 "-1.5"	45	58.6
2.0 "	59	72
2.5"	67	84
3.0 "	85	98
4.0"	114	127
5.0"	135.5	148x5.6
6.0"	155.4	170.4x5.6
8.0"	206	220x5.6
10"	258	272x5.6
12"	307	323x5.6

双销卡箍 13MHMM  
Double pin clamp 13MHMM

No.KST-F020



材质：AISI 304  
管道流量控制：Φ12.7-305 及 1/2"-12"  
Materia：AISI304  
Flux domination of pipeline：Φ12.7-305 & 1/2"-12"

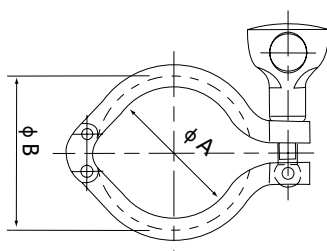

SIZE	ΦA	ΦB
1/2"-3/4"	20	28
1.5"	43.0	53.6
2.0"	57	67
2.5"	70.6	80.6
3.0"	84	94
4.0"	112	122
6.0"	155	170
8.0"	205	220.8
10"	258	272
12"	307	323



# 单销卡箍 13 MHH 13MHH HEAVY DUTY SINGLE PIN CLAMP

www.cnkingstone.com www.china-kst.com



(Fold Type)  
对叠



(Middle Type)  
夹中间

## 单销卡箍 13 MHH Single pin clamp 13 MHH

No.KST-F021

材质：AISI 304、AISI 316L  
管道流量控制：Φ12.7-305 及 1/2"-12"  
Material：AISI 304、AISI 316L  
Flux domination of pipeline：Φ12.7-305 & 1/2"-12"

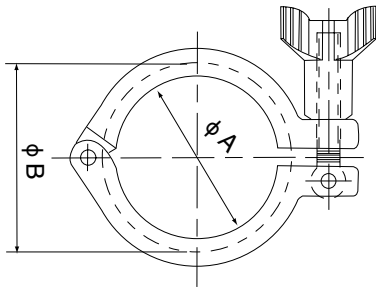

SIZE	ΦA	ΦB
A37	27.8	37
1-1 1/2	44.4	53.6
2.0"	57.8	67
2 1/2"	71.4	80.6
3.0"	84	94.2
3 1/2"	99	109.2
4.0"	110	122.2
4 1/2"	123	133.2
5"	135.5	148X3.5
5"	135.5	148X5.6
6.0"	155.4	170.4
8.0"	205	220
10"	258	272
12"	307	323

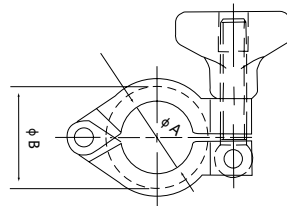

13MHH 迷你重型单销卡箍  
13MHH Mini heavy duty single pin clamp  
SIZE: 1/2" ~ 3/4"

# 高压卡箍 13MHP HIGH PRESSURE CLAMP 13 MHP

高压卡箍 13MHP  
High pressure clamp 13 MHP

No.KST-F022

材质：AISI 304  
管道流量控制：Φ12.7-305 及 1/2" -12"  
Material：AISI 304  
Flux domination of pipeline：Φ12.7-305 & 1/2" -12"

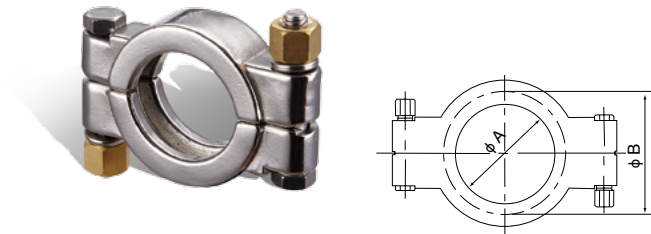

13MHP 高压卡箍  
SIZE:1/2"~3/4"

SIZE	ΦA	ΦB
1/2"-3/4"	20	28
1"-1.5"	43.3	52.0
2.0"	56.4	65.5
2.5"	69.5	79.0
3.0"	77.5	92.5
4.0"	108.8	120.5
5.0"	135.5	148
6.0"	158	170
8.0"	206	220
10"	258	272.8
12"	309	327.6

# 管支架 PIPE HOLDER

No.KST-F023

材质：AISI 304  
管道流量控制：Φ25-305 及 1" -12"  
Material：AISI 304  
Flux domination of pipeline：Φ25-305 & 1" -12"

ISO

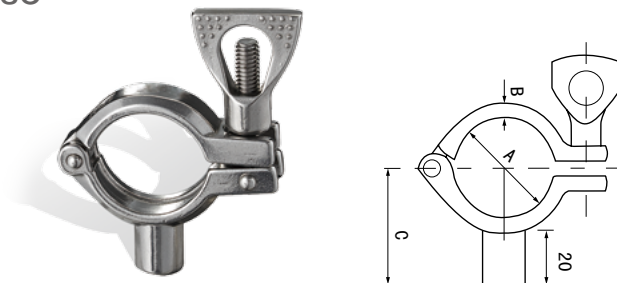

Size	A	B
1/2"	12.7	58.4
3/4"	19.1	62.5
1 1/2"	25.4	65.7
2"	38.1	72
2"	50.8	78.4
2 1/2"	63.5	84.8
3"	76.2	91
4"	101.6	103.8
5"	129	117.4
6"	154	130
8"	204	155
10"	254	180
12"	304	205

# 管支架 PIPE HOLDER

www.cnkingstone.com www.china-kst.com



No.KST-F024

## ISO-BSP

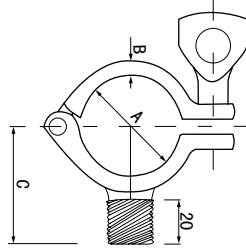

材质：AISI 304  
管道流量控制：Φ25-152 及 1" -6"  
Material：AISI 304  
Flux domination of pipeline：Φ25-152 & 1" -6"

Size	A	B	C
1/2"	12.70	7.50	38.00
3/4"	19.05	7.50	38.00
1"	25.40	7.50	38.00
1.1/2"	38.10	7.50	45.00
2"	50.80	7.50	50.00
2.1/2"	63.50	7.50	60.00
3"	76.20	9.00	68.00
4"	101.60	9.00	78.00
5"	127	9.00	78.00
6"	152.40	9.00	82.00

## ISO-BSP



No.KST-F025

材质：AISI 304  
管道流量控制：Φ25-152 及 1" -6"  
Material：AISI 304  
Flux domination of pipeline：Φ25-152 & 1" -6"

Size	A	B	C
1/2"	12.70	7.50	38.00
3/4"	19.05	7.50	38.00
1"	25.40	7.50	38.00
1.1/2"	38.10	7.50	45.00
2"	50.80	7.50	50.00
2.1/2"	63.50	7.50	60.00
3"	76.20	9.00	68.00
4"	101.60	9.00	78.00
5"	127	9.00	78.00
6"	152.40	9.00	82.00

## 3A-BSP

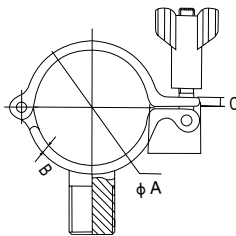

No.KST-F026

材质：AISI 304  
管道流量控制：Φ25-305 及 1" -12"  
Material：AISI 304  
Flux domination of pipeline：Φ25-305 & 1" -12"

Size	A	B	c
1"	25.4	3	5mm
1.5"	38.1	3	5mm
2"	50.8	4	6mm
2.5"	63.5	4	6mm
3"	76.2	5	7mm
4"	101.6	5	7mm
5"	127	5	7mm
6"	152.4	5	7mm
8"	203.2	6.5	7mm
10"	254	6.5	7mm
12"	304.8	6.5	7mm

# 卫生级人孔盖系列

## SANITARY MANHOLE COVERS

椭圆人孔盖 (压力型)  
Elliptic type manhole cover (with pressure)

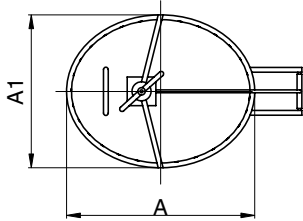

No.KST-M001

A	A1	高度 (Height)	t	Kg
430.0	330.0	75.0	8.0	
535.0	435.0	75.0	10.0	
635.0	525.0	75.0	12.0	

椭圆人孔盖 (压力型)  
Elliptic type manhole cover (with pressure)

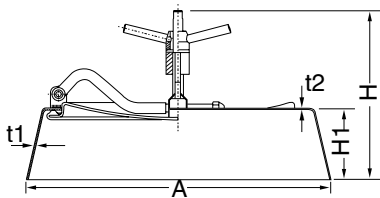

No.KST-M002

A 大	A 小	H1	H1	t1	t2	Kg
580.0	480.0	133.0	320.0	5.0	4.0	

圆型人孔盖 (非压力型)  
Circular type manhole cover (without pressure)

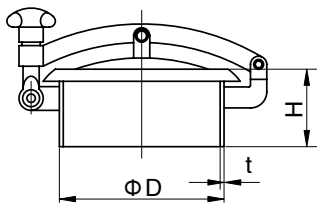

No.KST-M003

D	H	t	Kg
150.0	100.0	2.5	
200.0	100.0	2.5	
250.0	100.0	2.5	
300.0	100.0	2.5	
350.0	100.0	2.5	
400.0	100.0	2.0	
430.0	100.0	2.5	
450.0	100.0	2.5	
500.0	100.0	3.0	
600.0	100.0	4.0	

长方形人孔盖 (压力型)  
Square type manhole cover (with pressure)

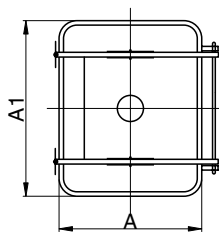

No.KST-M004

A	A1	高度 (Height)	t	Kg
330.0	430.0	65.0	8.0	
430.0	565.0	80.0	10.0	



# Y型过滤器

## Y-TYPE STRAINER

焊接 Y 型过滤器  
Welded Y-type strainer

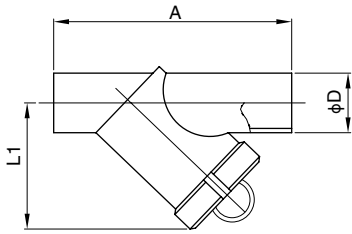

DIN

No.KST-G20102

Size	A	D	L1	Kg
DN25	125.0	28.0	95.0	
DN32	140.0	34.0	104.0	
DN40	165.0	40.0	110.0	
DN50	195.0	52.0	140.0	
DN65	230.0	70.0	185.0	
DN80	280.0	85.0	220.0	
DN100	340.0	104.0	248.0	

SMS/ISO/IDF/3A

No.KST-G20103

Size	A	D	L1	Kg
1"	25	123.0	25.4	90.0
1 1/2"	32	135.0	32.0	102.0
1 1/4"	38	144.0	38.1	107.0
2"	51	195.0	50.8	140.0
2 1/2"	63	210.0	63.5	165.0
3"	76	240.0	76.2	190.0
3 1/2"	89	295.0	89.0	225.0
4"	102	340.0	101.6	249.0

卡箍 Y 型过滤器  
Clamped Y-type strainer

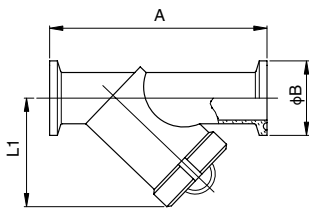

DIN

No.KST-G10104

Size	A	B	L1	Kg
DN25	125.0	50.5	95.0	
DN32	140.0	50.5	104.0	
DN40	165.0	50.5	110.0	
DN50	195.0	64.0	140.0	
DN65	230.0	91.0	185.0	
DN80	280.0	106.0	220.0	
DN100	340.0	119.0	248.0	

卡箍 Y 型过滤器  
Clamped Y-type strainer

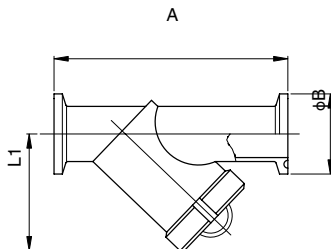

SMS/ISO/IDF/3A

No.KST-G10105

Size	A	B	L1	Kg
1	25	123.0	50.5	90.0
1 1/2	32	135.0	50.5	120.0
1 1/4	38	144.0	50.5	107.0
2	51	195.0	64.0	140.0
2 1/2	63	210.0	77.5	165.0
3	76	240.0	91.0	190.0
3 1/2	89	295.0	106.0	225.0
4	102	340.0	119.0	249.0



# 卡箍式直通过滤器

www.cnkingstone.com www.china-kst.com

## CLAMPED STRAIGHT STRAINER

卡箍式直通过滤器  
Clamped straight strainer

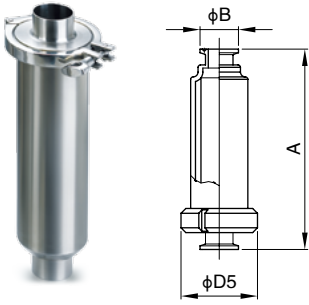

DIN

No.KST-G10106

Size	A	B	D5	Kg
DN25	306.0	50.0	95.0	
DN32	306.0	50.0	110.0	
DN40	306.0	50.0	110.0	
DN50	406.0	64.0	110.0	
DN65	503.0	77.5	127.0	
DN80	561.0	91.0	148.0	
DN100	662.0	119.0	178.0	

卡箍式直通过滤器  
Clamped straight strainer

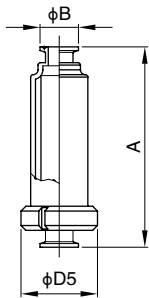

SMS/ISO/IDF/3A

No.KST-G10107

Size	A	B	D5	Kg
1"	25	306.0	50.5	95.0
1 1/2"	32	306.0	50.5	110.0
1 1/4"	38	306.0	50.5	110.0
2"	51	406.0	64.0	110.0
2 1/2"	63	503.0	77.5	127.0
3"	76	561.0	91.0	148.0
4"	102	662.0	119.0	178.0

卡箍角式过滤器  
Clamped angle strainer

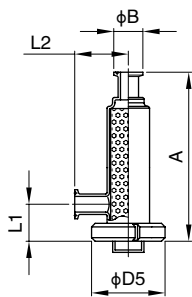

DIN

No.KST-G10108

Size	A	B	D5	L1	L2	Kg
DN25	306.0	50.0	95.0	60.0	70.0	
DN32	306.0	50.0	110.0	60.0	70.0	
DN40	306.0	50.0	110.0	80.0	70.0	
DN50	406.0	64.0	110.0	100.0	72.0	
DN65	503.0	91.0	127.0	120.0	85.0	
DN80	561.0	106.0	148.0	140.0	96.0	
DN100	662.0	119.0	178.0	160.0	117.0	

卡箍角式过滤器  
Clamped angle strainer

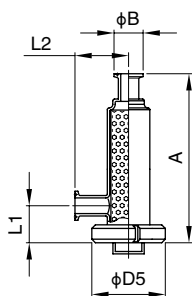

SMS/ISO/IDF/3A

No.KST-G10109

Size	A	B	D5	L1	L2	Kg
1"	25	306.0	50.5	95.0	60.0	70.0
1 1/2"	32	306.0	50.5	110.0	60.0	70.0
1 1/4"	38	306.0	50.5	110.0	80.0	70.0
2"	51	406.0	64.0	110.0	100.0	72.0
2 1/2"	63	503.0	77.5	127.0	120.0	85.0
3"	76	561.0	91.0	148.0	140.0	96.0
4"	102	662.0	119.0	178.0	160.0	117.0

浙江金斯顿流体设备有限公司  
ZHEJIANG KINGSTONE FLUID EQUIPMENT CO., LTD.

地址：温州经济技术开发区滨海园区明珠路 757 号

Add: No. 757, Mingzhu Road, Binhai Garden,  
Wenzhou Economic Development Zone, China.

电话 (Tel): +86-577-8699 5222

传真 (Fax): +86-577-8699 8689 86995111

邮编 (P.c) : 325025

[www.cnkingstone.com](http://www.cnkingstone.com)

[www.china-kst.com](http://www.china-kst.com)

E-mail: [kingst\\_valve@aliyun.com](mailto:kingst_valve@aliyun.com)

本目录所有产品规格、如有更改恕不另行通知



官方网站



微信公众号



诚招代理商：

